

*Corrugated Horn Antenna*  
*22dBi Typ Gain, 140-220GHz Frequency Range*

**Corrugated Horn Antenna Data Sheet**

**RM-CHA5-22**

**Specifications**

<b>RM-CHA5-22</b>		
Parameters	Specification	Unit
Frequency Range	140-220	GHz
Gain	22 Typ.	dBi
VSWR	1.6 Typ	
Isolation	30 Typ.	dB
Polarization	Linear	
Waveguide	WR5	
Material	Al	
Finishing	Paint	
Size(L*W*H)	30.4*19.1*19.1 (±5)	mm
Weight	0.011	kg

*Corrugated Horn Antenna*  
*22dBi Typ Gain, 140-220GHz Frequency Range*

**Corrugated Horn Antenna Data Sheet**

**RM-CHA5-22**

**Outline Drawing**

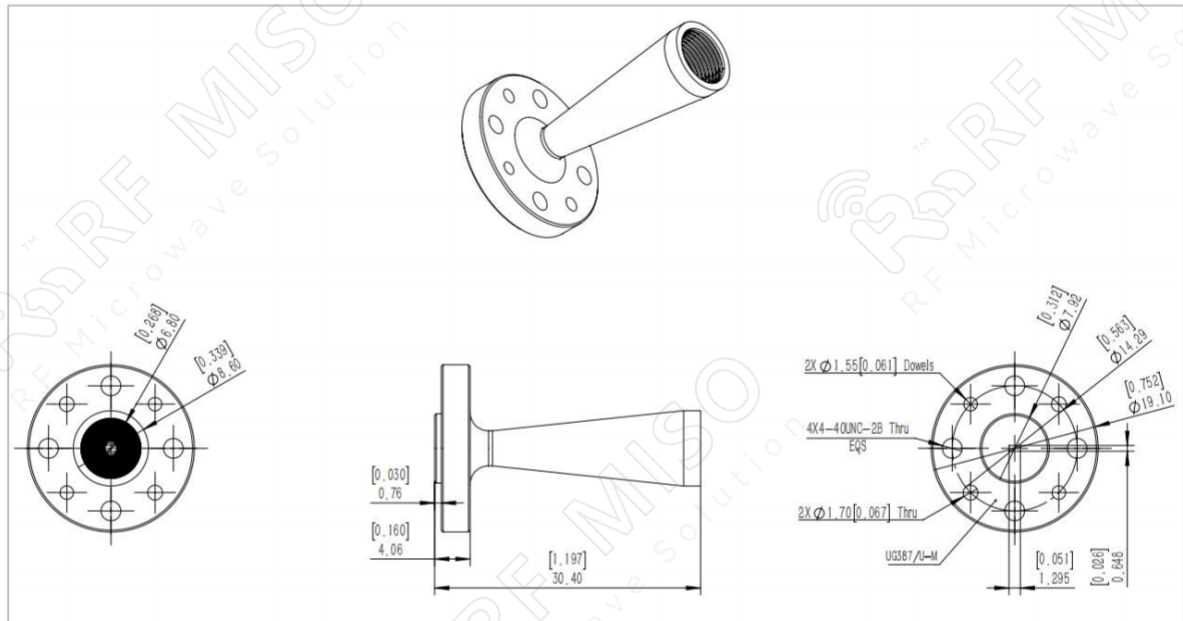

**Simulated Results**

**Gain**

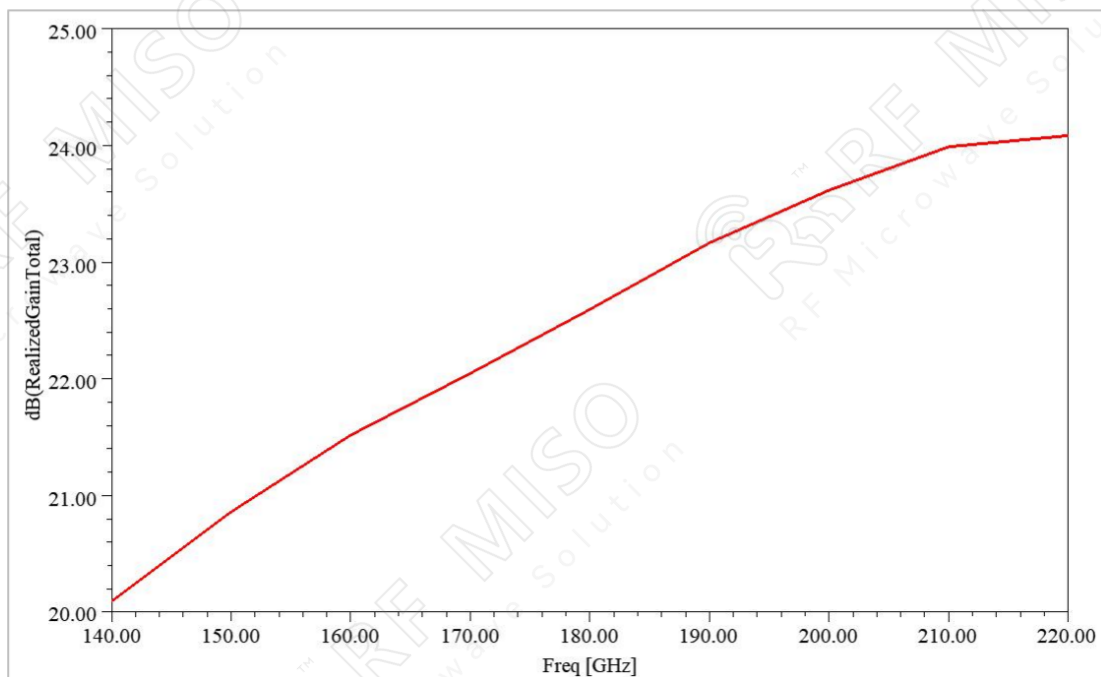

*Corrugated Horn Antenna*  
*22dBi Typ Gain, 140-220GHz Frequency Range*

**Corrugated Horn Antenna Data Sheet**

**RM-CHA5-22**

Isolation

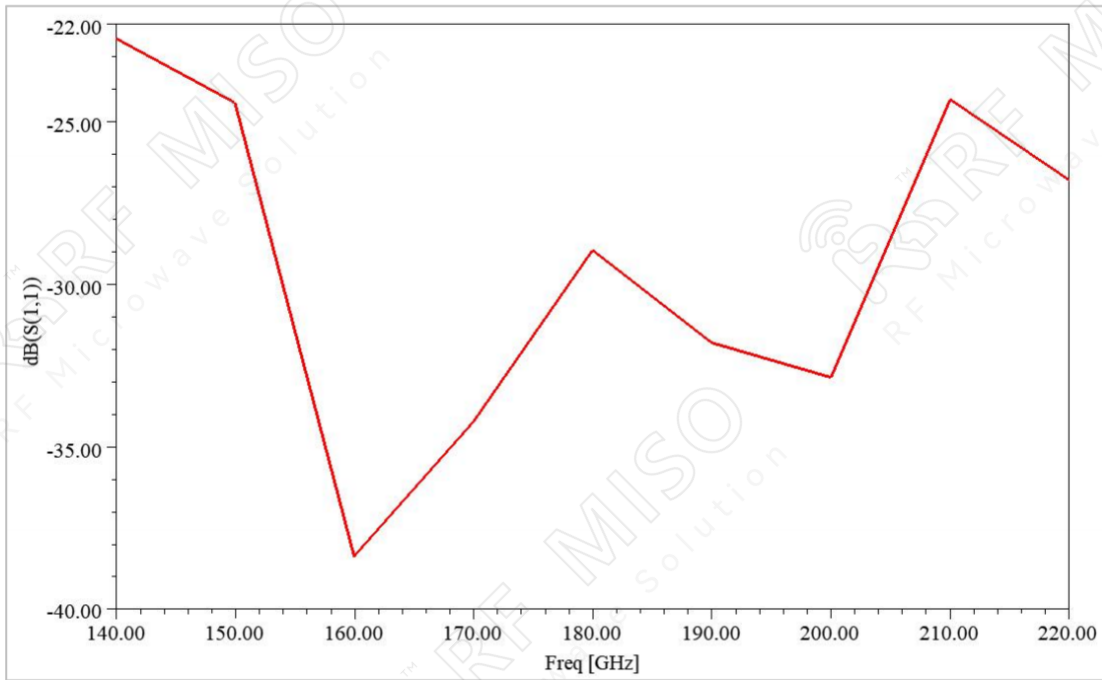

Gain Pattern

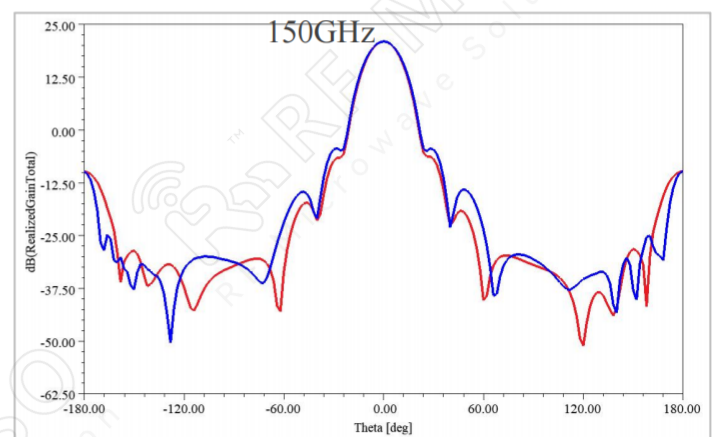
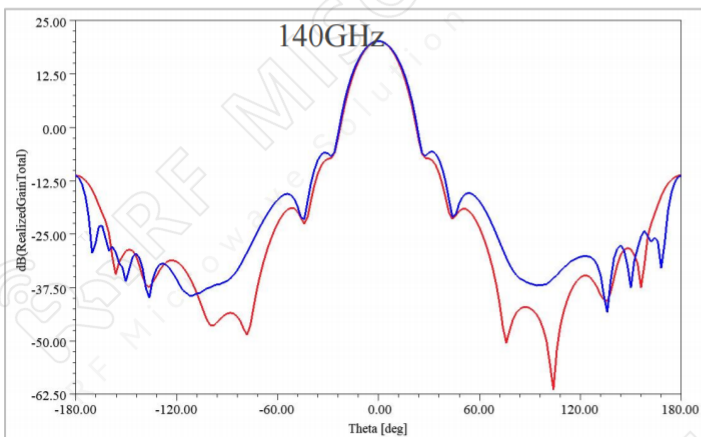

*Corrugated Horn Antenna*  
*22dBi Typ Gain, 140-220GHz Frequency Range*

**Corrugated Horn Antenna Data Sheet**

**RM-CHA5-22**

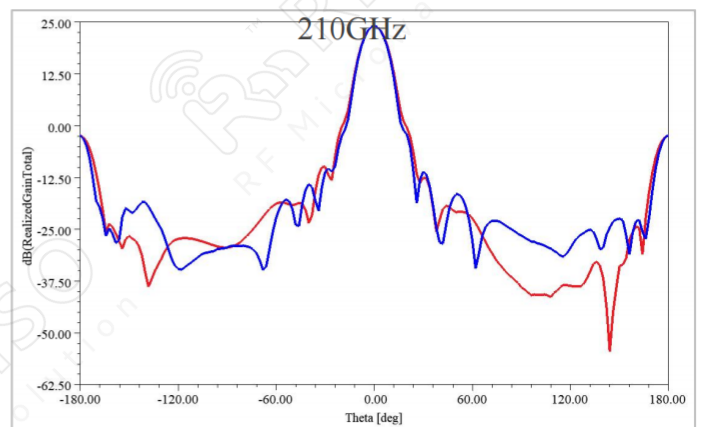
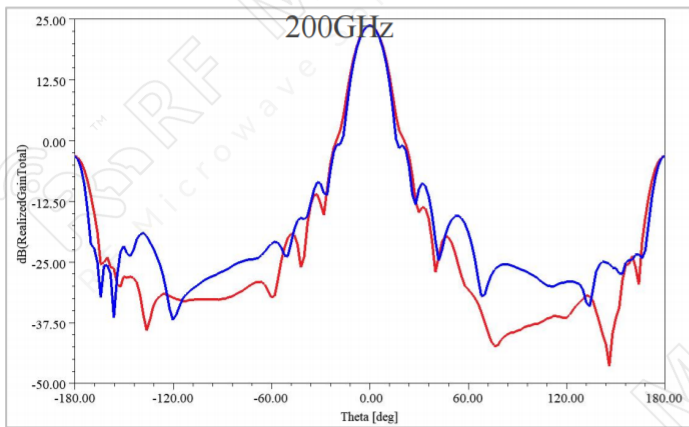
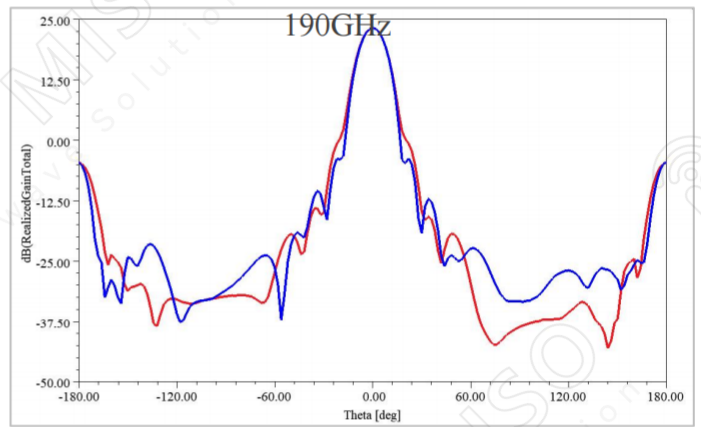
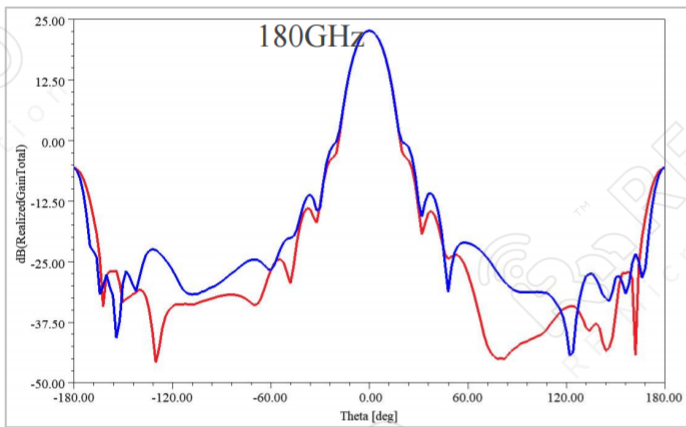
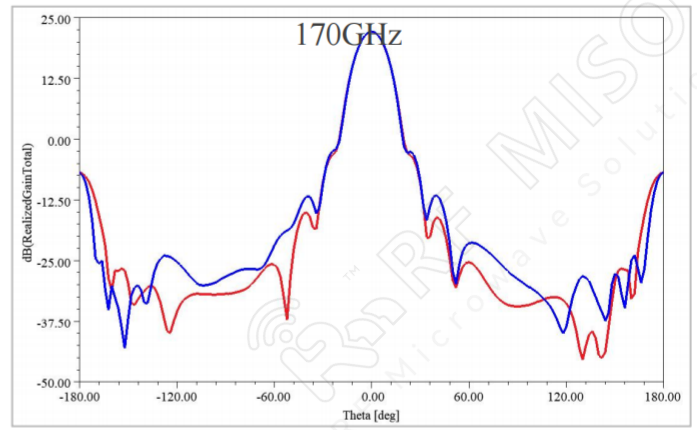
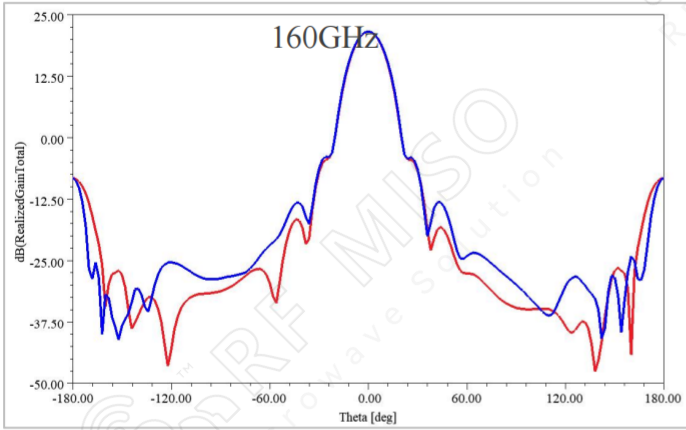

*Corrugated Horn Antenna*  
*22dBi Typ Gain, 140-220GHz Frequency Range*

**Corrugated Horn Antenna Data Sheet**

**RM-CHA5-22**

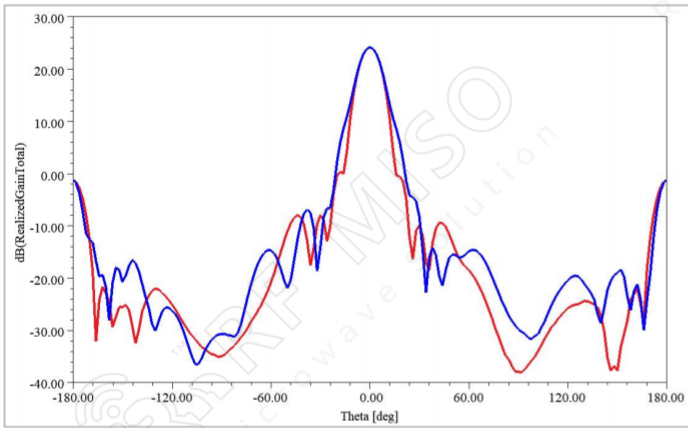

220GHz