



## Dual Polarized Horn Antenna Data

## MT-DPHA6090-15

### Features

- Full E Band Performance
- Dual Polarization
- High Port Isolation
- Precisely Machined and Gold Plated

### Description

The **MT-DPHA6090-15** from Microtech is a full-band, dual-polarized, WR-12 horn antenna assembly that operates in the frequency range of 60 GHz to 90 GHz. The antenna features an integrated orthogonal mode converter that provides high port isolation. The MT-DPHA6090-15 supports vertical and horizontal waveguide orientations and has a typical 35 dB cross-polarization suppression, a nominal gain of 15 dBi at the center frequency, a typical 3db beamwidth of 33 degrees in the E-plane, a typical 3db beamwidth of 33 degrees in the H-plane. The input to the antenna is a WR-12 waveguide with a UG-387/U-M threaded flange.

### Specifications

MT-DPHA6090-15		
Item	Specification	Units
Frequency Range	60-90	GHz
Gain	15	dBi
VSWR	1.3:1	
Polarization	Dual	
Horizontal 3dB Beam Width	33	Degrees
Vertical 3dB Beam Width	28	Degrees
Port Isolation	45	dB
Waveguide Size	WR-12	
Flange Designation	UG-387/U	g
Size	27.90*51.70	mm
Weight	74	g
Body Material and Finish	Cu, Gold	

Dual Polarized Horn Antenna  
15 dBi Gain, 60GHz-90GHz Frequency Range



**Dual Polarized Horn Antenna Data**

**MT-DPHA6090-15**

**Outline Drawing**

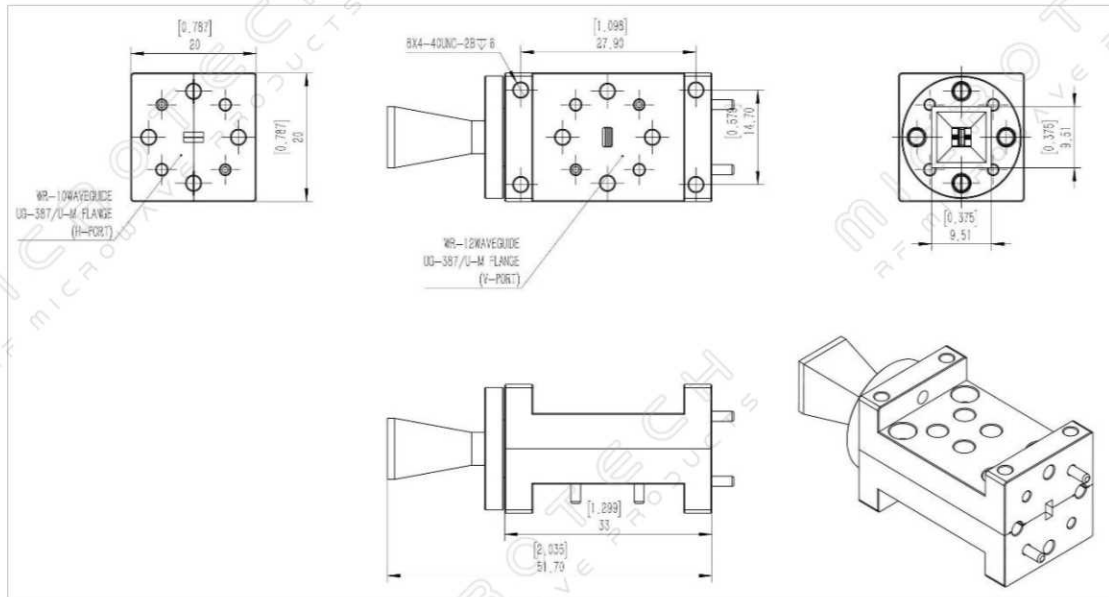

**Simulated Data**

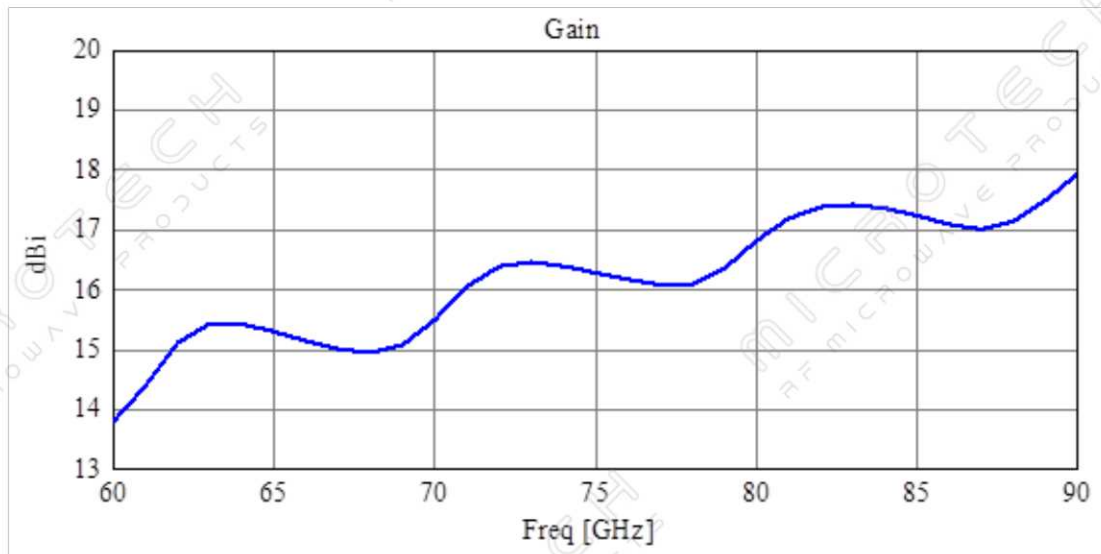



Dual Polarized Horn Antenna  
15 dBi Gain, 60GHz-90GHz Frequency Range

**Dual Polarized Horn Antenna Data**

**MT-DPHA6090-15**

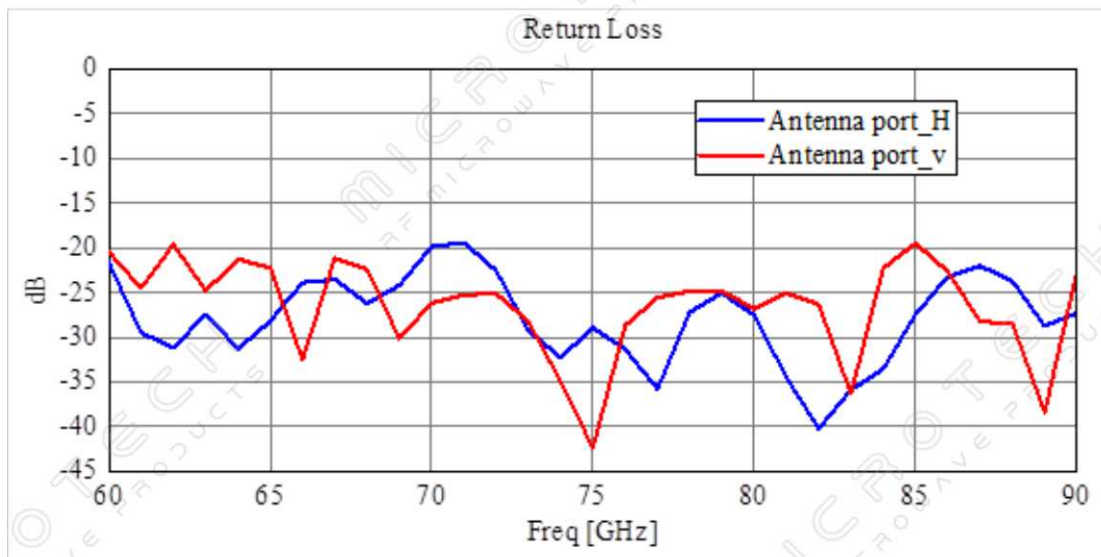
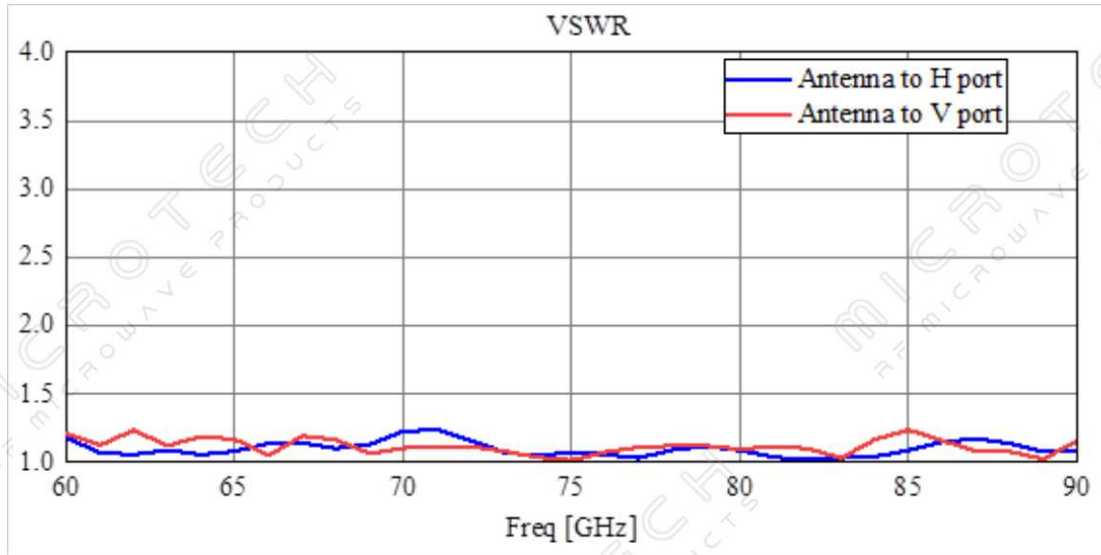



Dual Polarized Horn Antenna  
15 dBi Gain, 60GHz-90GHz Frequency Range

**Dual Polarized Horn Antenna Data**

**MT-DPHA6090-15**

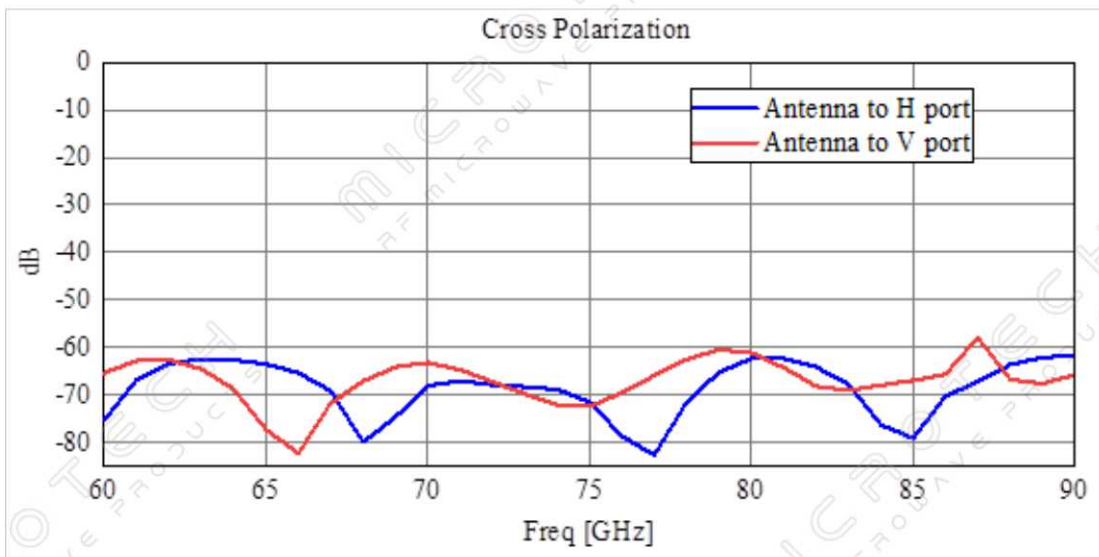
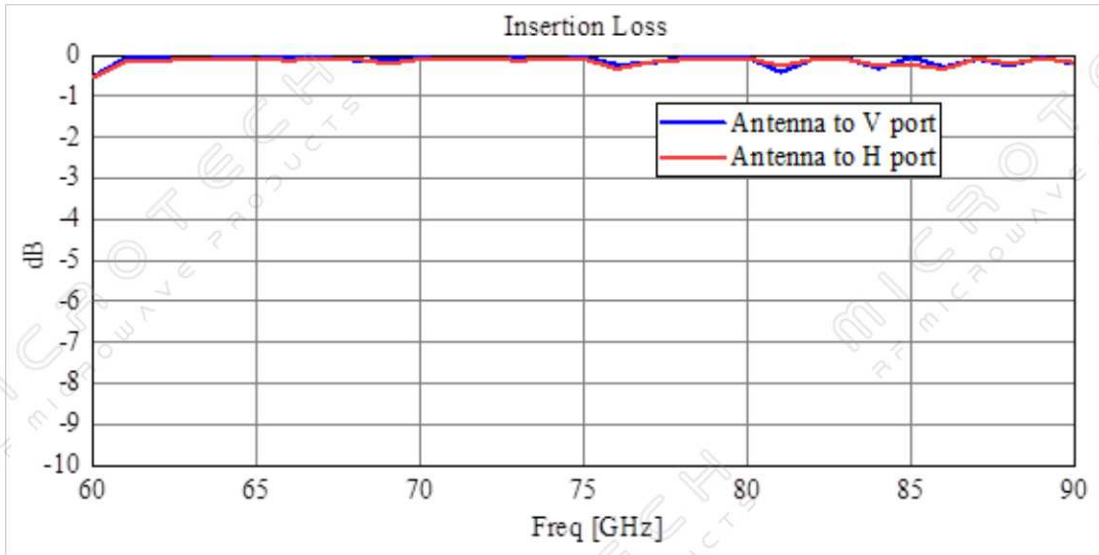





Dual Polarized Horn Antenna  
15 dBi Gain, 60GHz-90GHz Frequency Range

**Dual Polarized Horn Antenna Data**

**MT-DPHA6090-15**

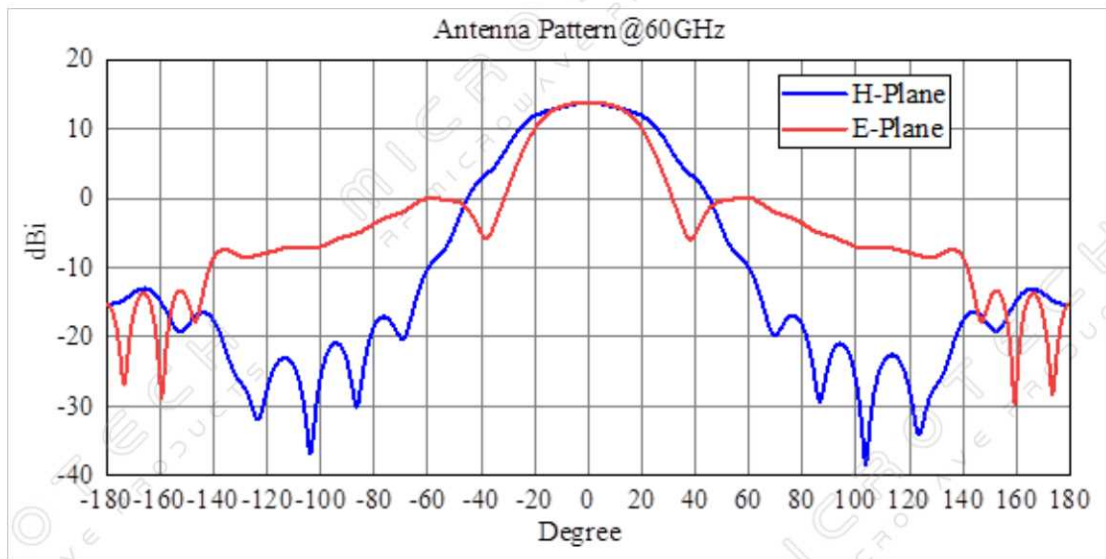
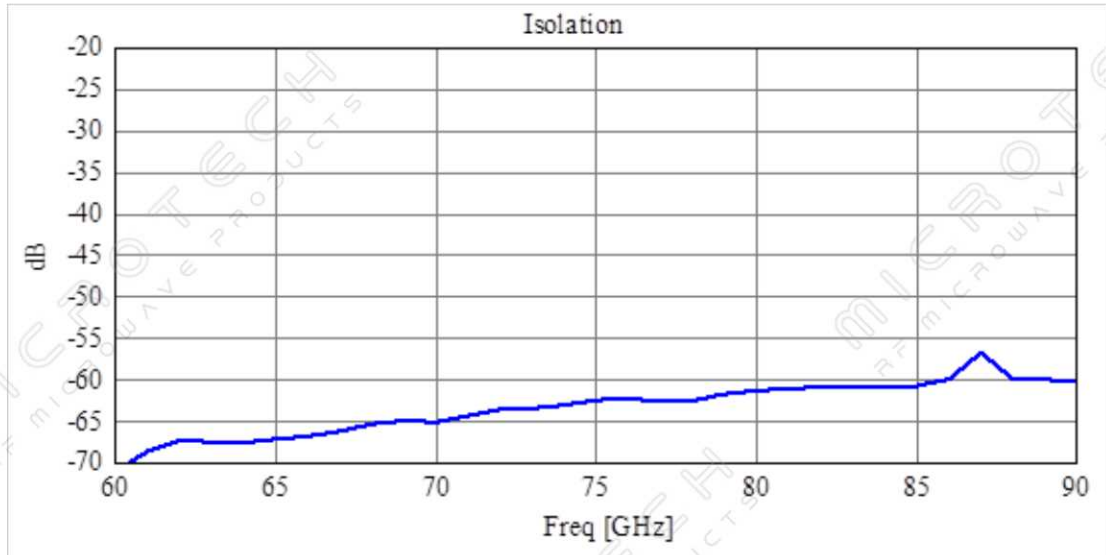



Dual Polarized Horn Antenna  
15 dBi Gain, 60GHz-90GHz Frequency Range

**Dual Polarized Horn Antenna Data**

**MT-DPHA6090-15**

