

*Biconical Antenna 1-20 GHz Frequency Range  
2 dBi Typ. Gain, Slant polarization*

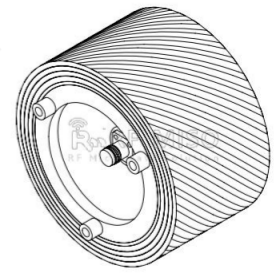

## Biconical Antenna Data Sheet

**RM-BCA120-2**

### Descriptions

RF MISO's **Model RM-BCA120-2** is a slant polarization biconical antenna that operates from 1-20GHz. The antenna offers a gain 2 dBi Typ. and low VSWR 1.5:1 with SMA-Female connector. The use of foam covers between the outer polarization layers can effectively reduce the wind resistance on the antenna surface, especially in outdoor applications, and improve the mechanical stability of the antenna.

### Specifications

RM-BCA120-2		
Parameters	Typical	Units
Frequency Range	1-20	GHz
Gain	2 Typ.	dBi
VSWR	1.5 Typ.	
Polarization	45° slant	
Connector	SMA-Female	
Body Material	Al	
Size	Φ75.5*49	mm
Weight	1.423	Kg
Power Handling,CW	50	W
Power Handling,Peak	100	W

*Biconical Antenna 1-20 GHz Frequency Range  
2 dBi Typ. Gain, Slant polarization*

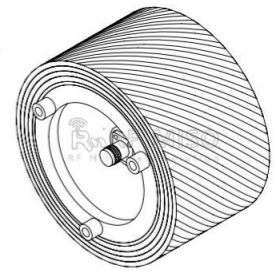

**Biconical Antenna Data Sheet**

**RM-BCA120-2**

**Outline Drawing**

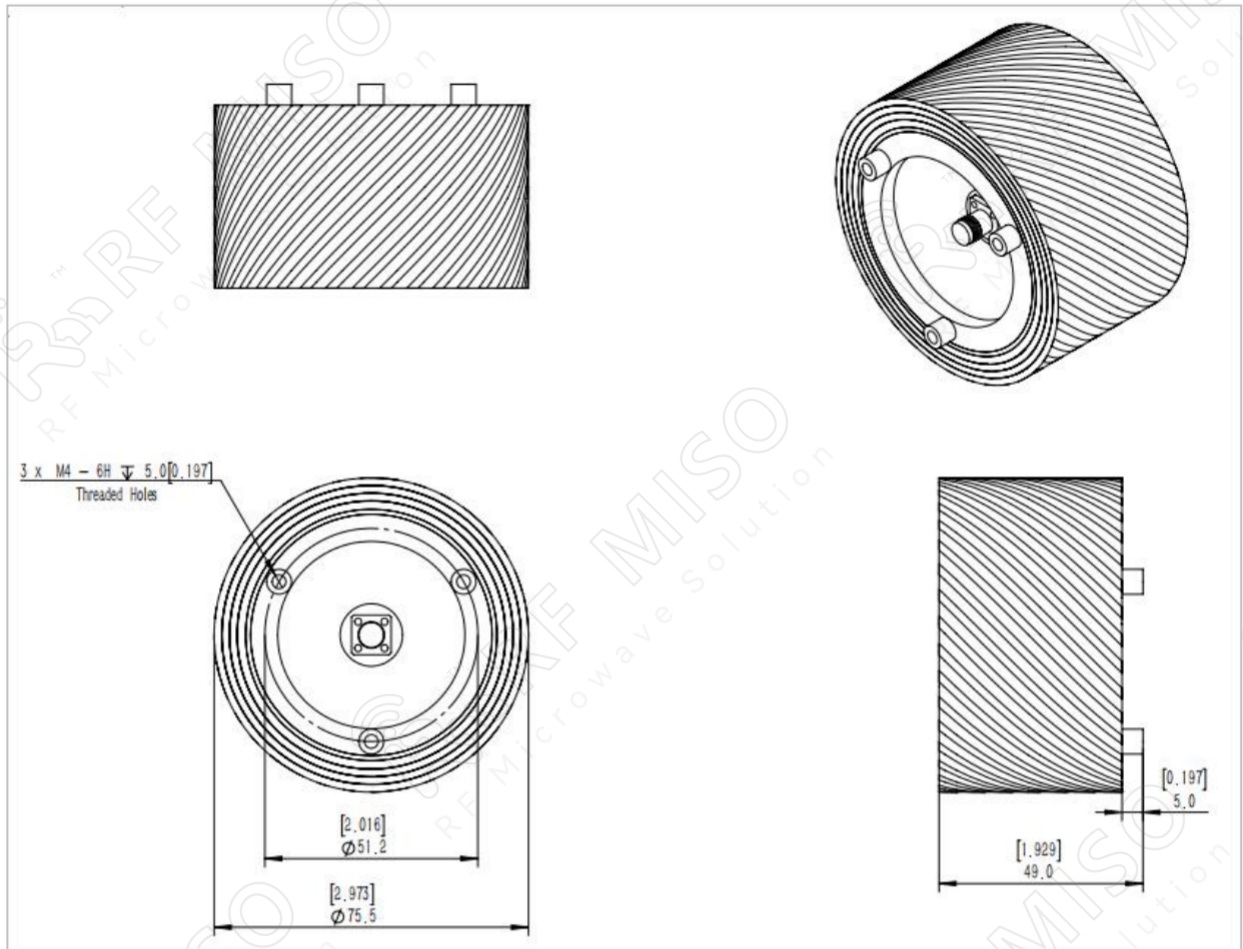

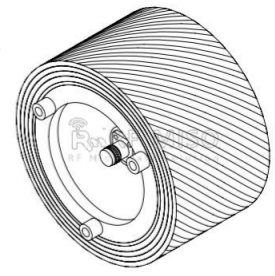

*Biconical Antenna 1-20 GHz Frequency Range  
2 dBi Typ. Gain, Slant polarization*

**Biconical Antenna Data Sheet**

**RM-BCA120-2**

**Simulation Data**

**VSWR**

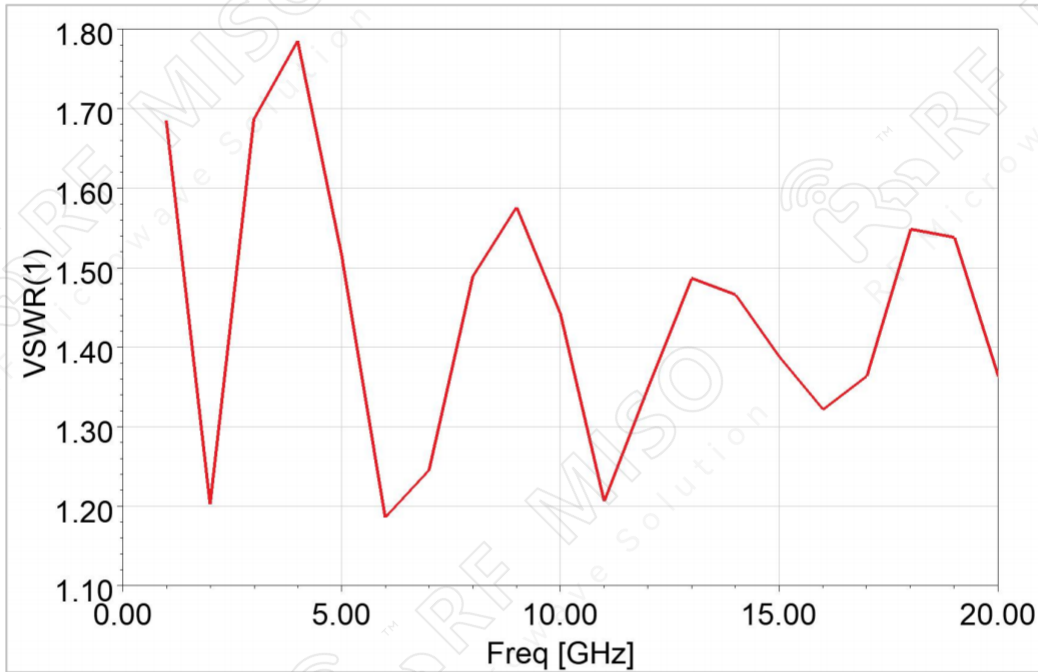

**Gain**

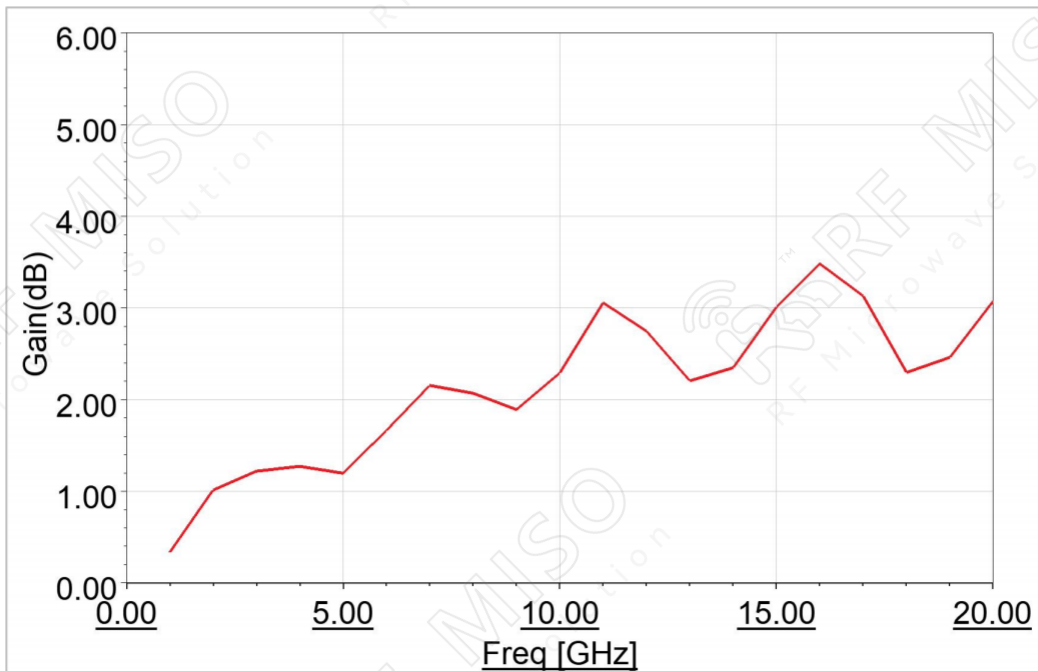

*Biconical Antenna 1-20 GHz Frequency Range  
2 dBi Typ. Gain, Slant polarization*

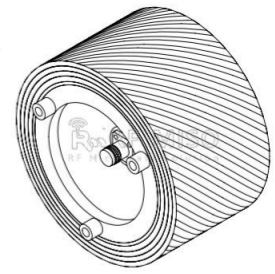

**Biconical Antenna Data Sheet**

**RM-BCA120-2**

**Pattern**

1GHz

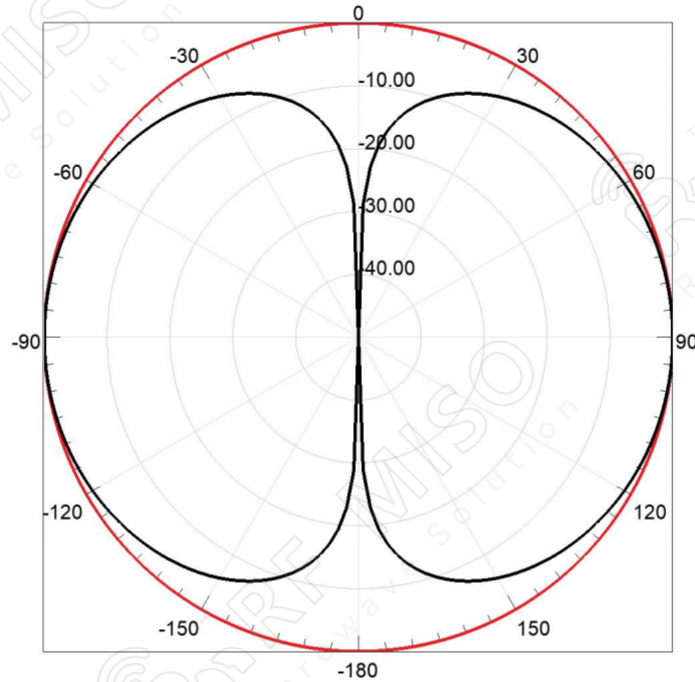

2GHz

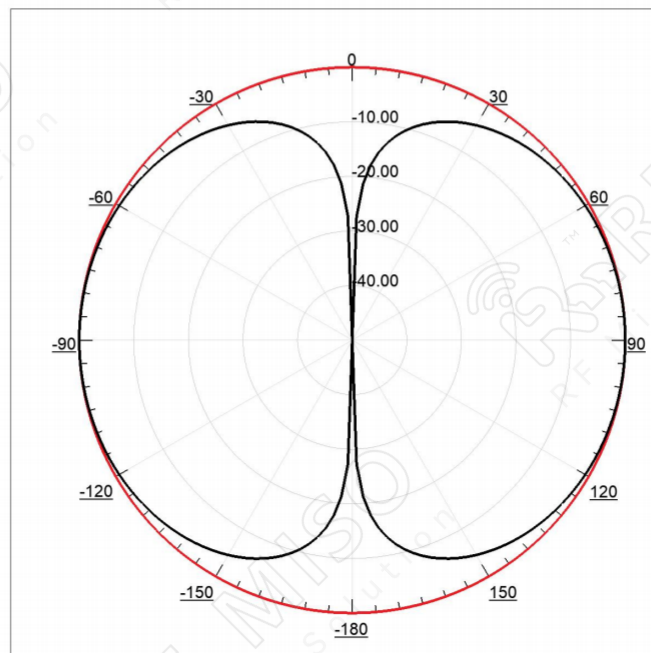

*Biconical Antenna 1-20 GHz Frequency Range  
2 dBi Typ. Gain, Slant polarization*

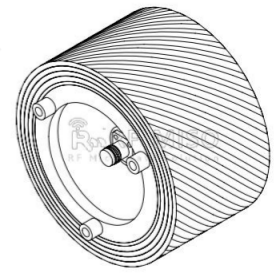

**Biconical Antenna Data Sheet**

**RM-BCA120-2**

5GHz

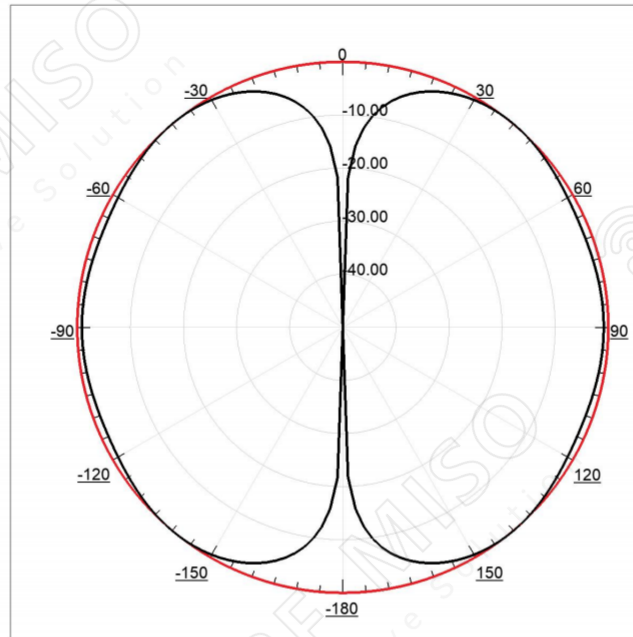

15GHz

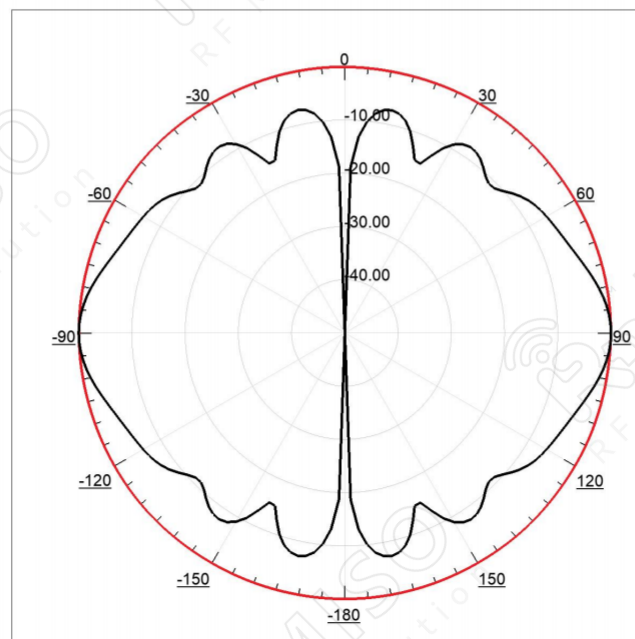

*Biconical Antenna 1-20 GHz Frequency Range  
2 dBi Typ. Gain, Slant polarization*

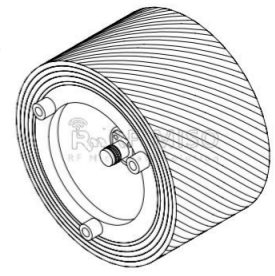

**Biconical Antenna Data Sheet**

**RM-BCA120-2**

25GHz

