



Broadband Horn Antenna
10 dBi Typ. Gain, 0.8 GHz-8 GHz Frequency Range

Broadband Horn Antenna Data Sheet

RM-BDHA088-10N

Features

- Double-Ridge Waveguide
- Linear Polarization
- N Female Connector
- Mounting Bracket Included

Description

The **RM-BDHA088-10N** from RF MISO is a broadband gain horn antenna that operates from 0.8 to 8 GHz. The antenna offers a typical gain of 10 dBi and VSWR1.5:1 with an N Female coaxial connector. The antenna is used in a variety of applications such as microwave testing, satellite antenna testing, direction finding, surveillance, plus EMC and antenna measurements.

Specifications

RM-BDHA088-10N		
Item	Specification	Units
Frequency Range	0.8-8	GHz
Gain	10 Typ.	dBi
VSWR	1.5:1 Typ.	
Polarization	Linear	
Connector	N-F	
Material	Al	
Surface Treatment	Paint	
Size	288.17*162.23*230	mm
Weight	2.766	kg
Power Handling, CW	300	W
Power Handling, Peak	500	W



Broadband Horn Antenna
10 dBi Typ. Gain, 0.8 GHz-8 GHz Frequency Range

Broadband Horn Antenna Data Sheet

RM-BDHA088-10N

Outline Drawing (Size: mm)

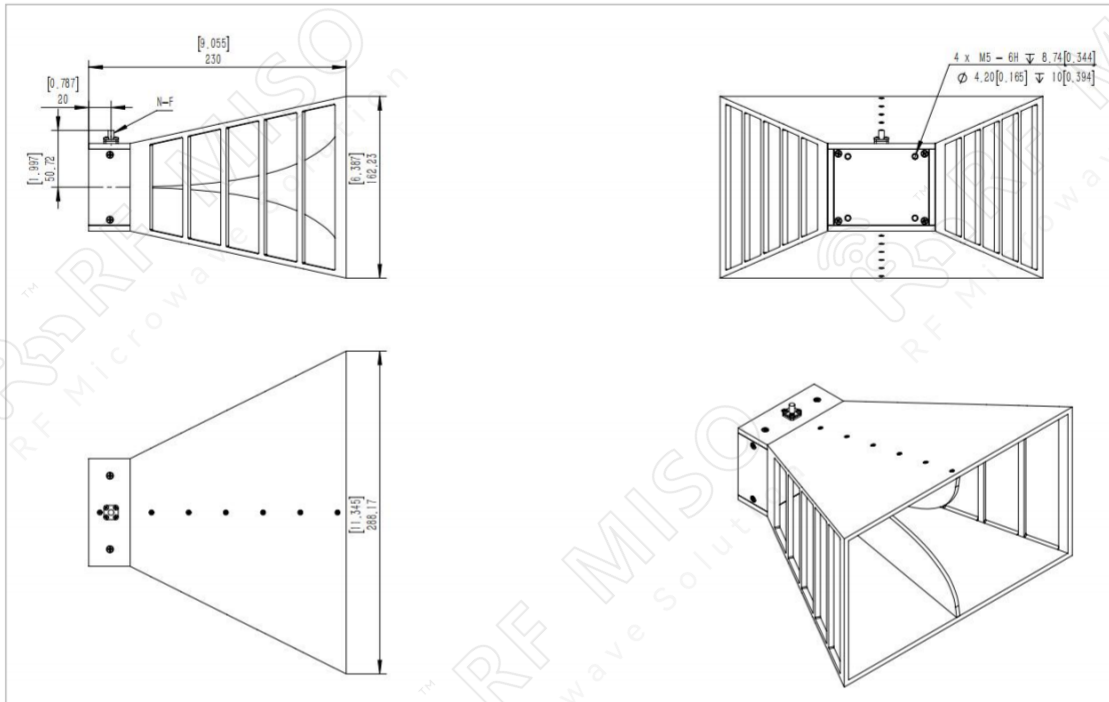

Outline Drawing with Mounting Bracket:

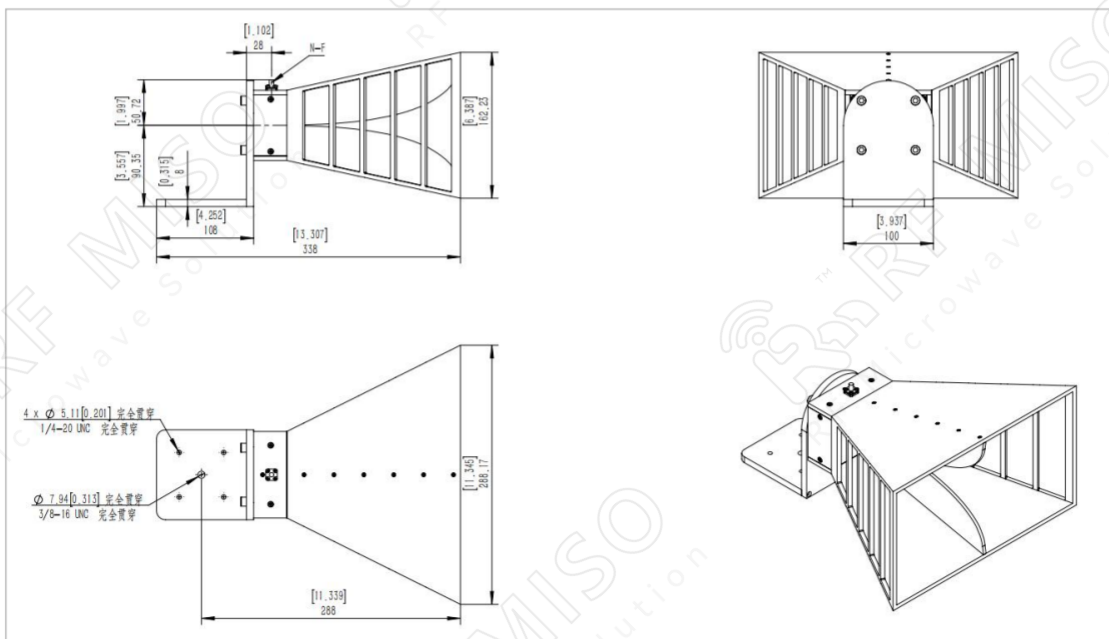



Broadband Horn Antenna
10 dBi Typ. Gain, 0.8 GHz-8 GHz Frequency Range

Broadband Horn Antenna Data Sheet

RM-BDHA088-10N

Simulated Data

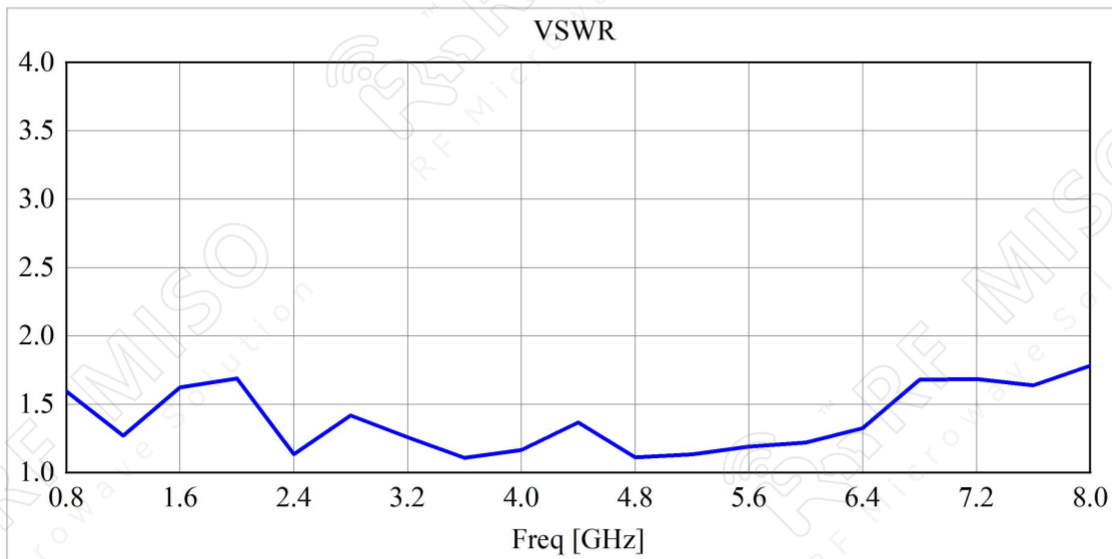
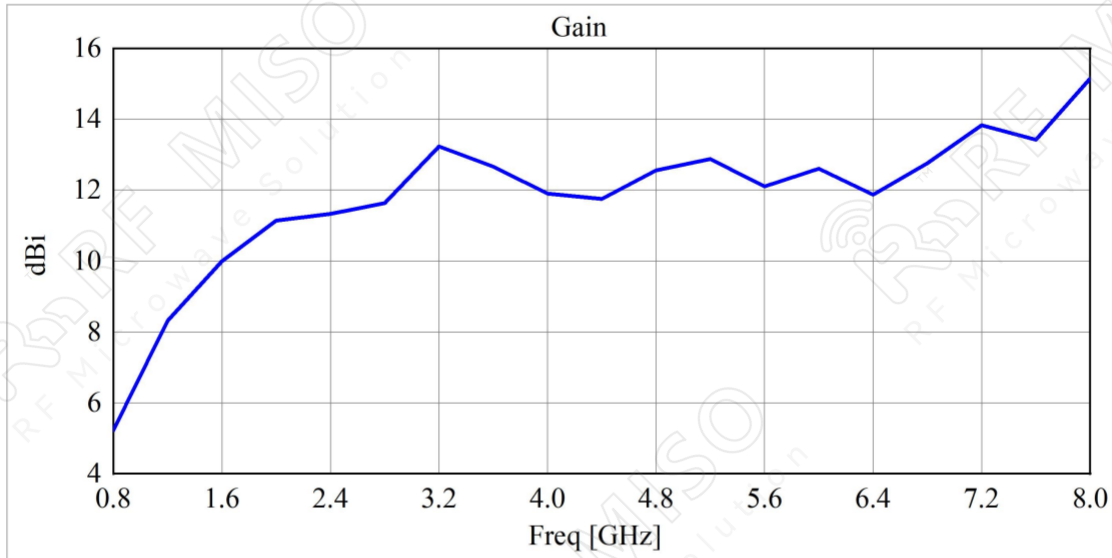



Broadband Horn Antenna
10 dBi Typ. Gain, 0.8 GHz-8 GHz Frequency Range

Broadband Horn Antenna Data Sheet

RM-BDHA088-10N

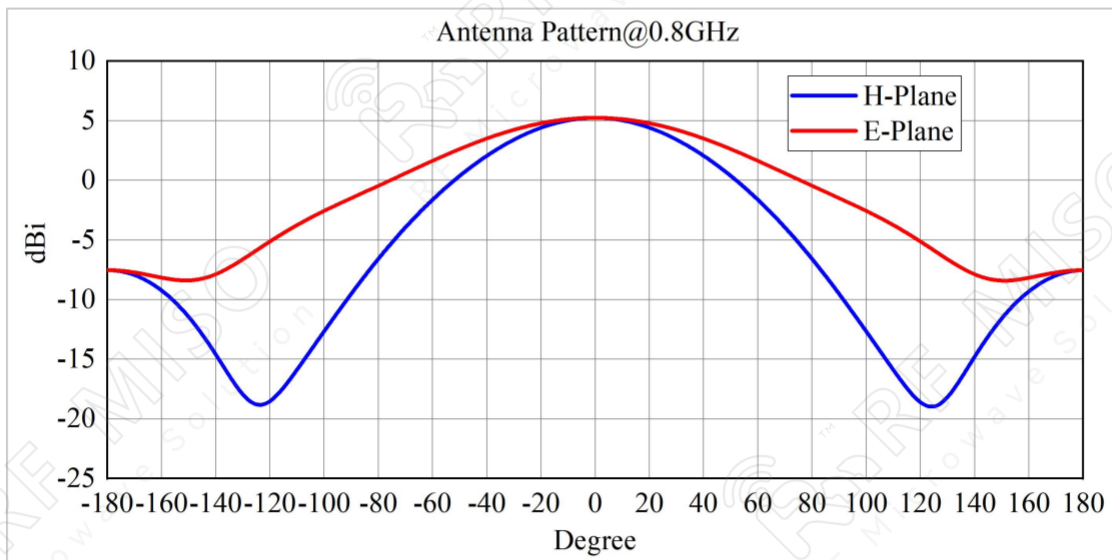
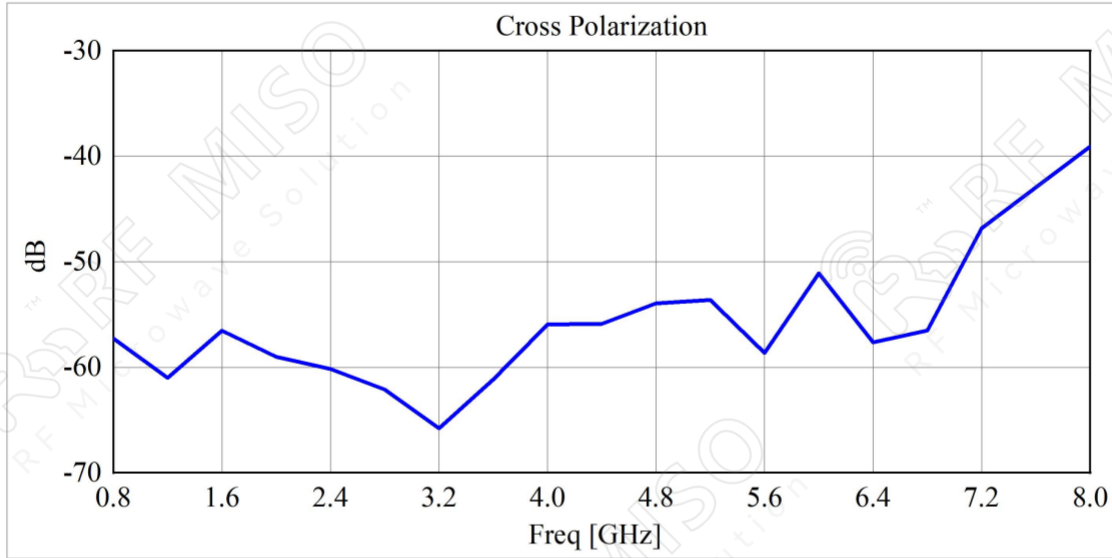



Broadband Horn Antenna
10 dBi Typ. Gain, 0.8 GHz-8 GHz Frequency Range

Broadband Horn Antenna Data Sheet

RM-BDHA088-10N

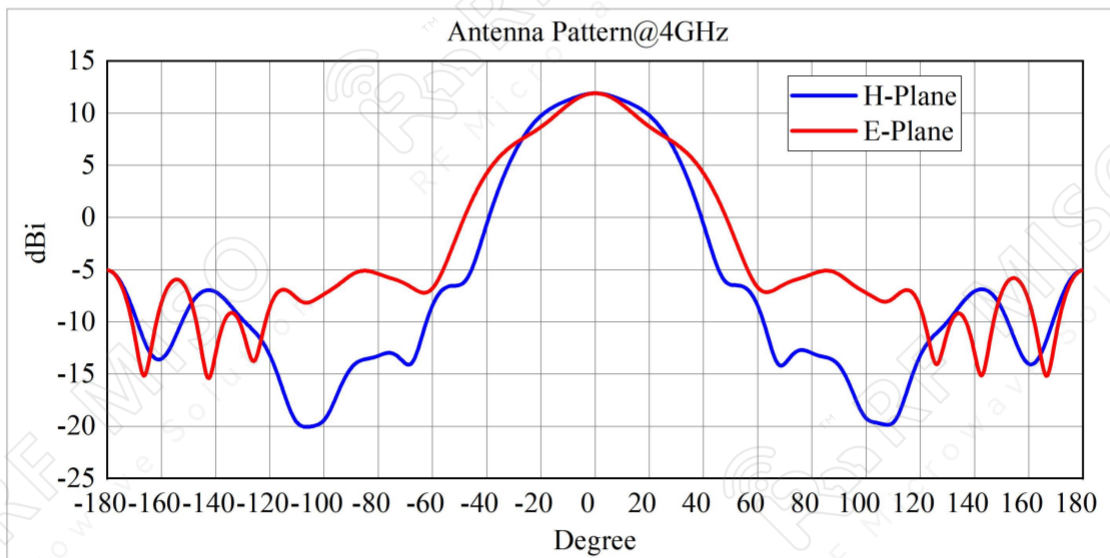
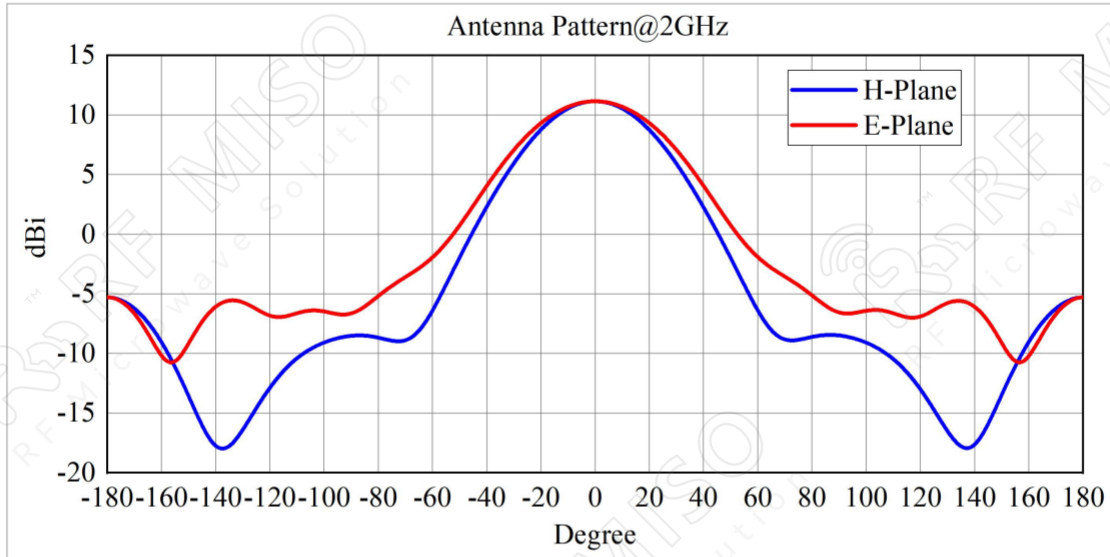



Broadband Horn Antenna
10 dBi Typ. Gain, 0.8 GHz-8 GHz Frequency Range

Broadband Horn Antenna Data Sheet

RM-BDHA088-10N

