

*Broadband Horn Antenna  
12 dBi Typ. Gain, 1-40 GHz Frequency Range*

## Broadband Horn Antenna Data Sheet

**RM-BDHA140-12**

### Features

- Ideal for Antenna Measurement
- Low VSWR
- Broadband Operation
- Linear Polarized

### Descriptions

RF MISO's **Model RM-BDHA140-12** is a linear polarized broadband horn antenna that operates from 1 to 40 GHz. The antenna offers a typical gain of 12 dBi and low VSWR <2 with 2.92-Female connector. The antenna is used for long time trouble-free applications in indoor and outdoor environments. It can be widely used in EMI detection, orientation, reconnaissance, antenna gain and pattern measurement and other applications.

### Specifications

RM-BDHA140-12		
Parameters	Typical	Units
Frequency Range	1-40	GHz
Gain	12 Typ.	dBi
VSWR	<2	
Polarization	Linear	
Connector	2.92-Female	
Treatment	Paint	
Size(L*W*H)	168.5*185.5*144.6(±5)	mm
Weight	0.334	Kg
Material	Al	

Broadband Horn Antenna  
12 dBi Typ. Gain, 1-40 GHz Frequency Range

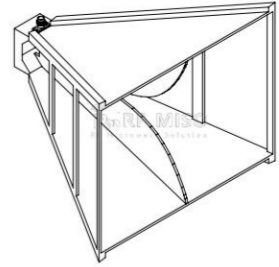

**Broadband Horn Antenna Data Sheet**

**RM-BDHA140-12**

**Mechanical Drawing**

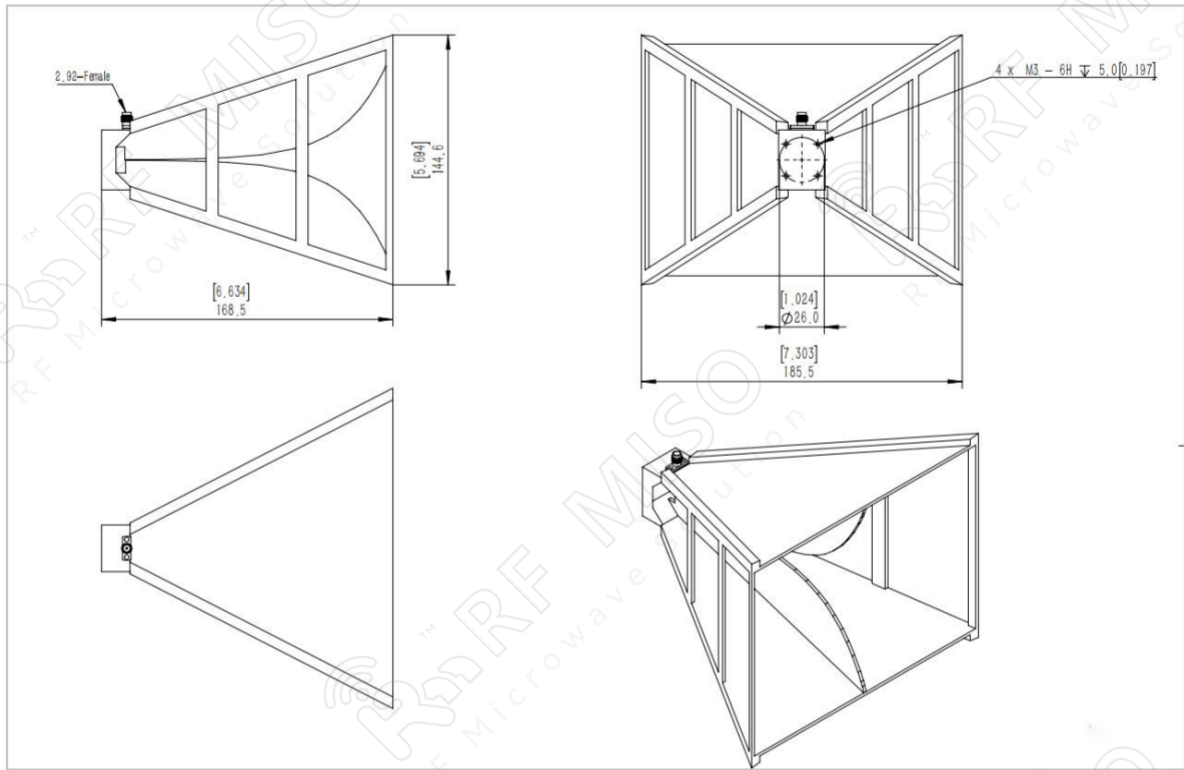

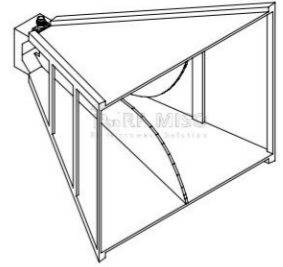

*Broadband Horn Antenna*  
*12 dBi Typ. Gain, 1-40 GHz Frequency Range*

**Broadband Horn Antenna Data Sheet**

**RM-BDHA140-12**

**Simulation Result**

VSWR

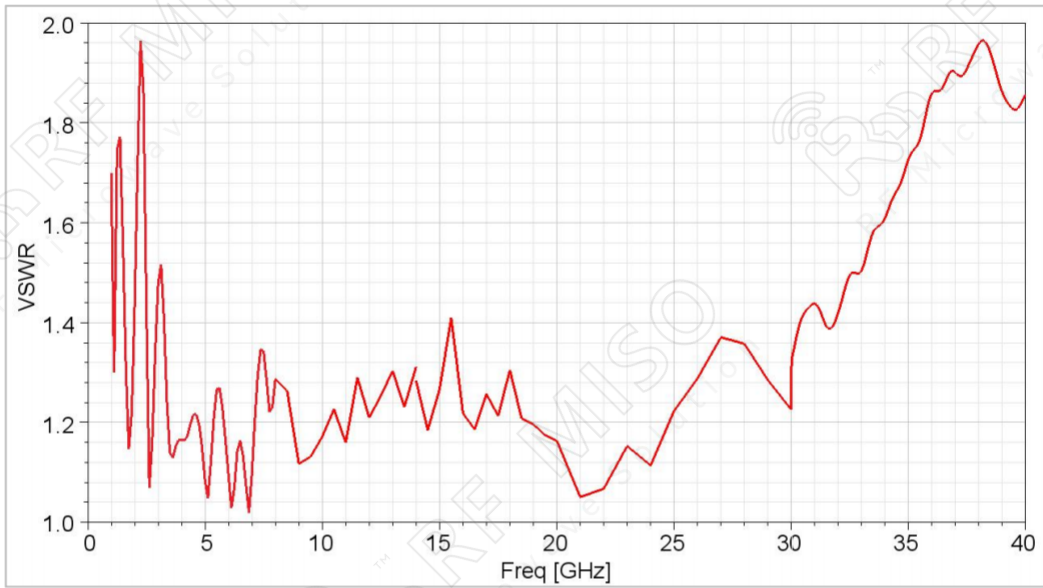

Gain

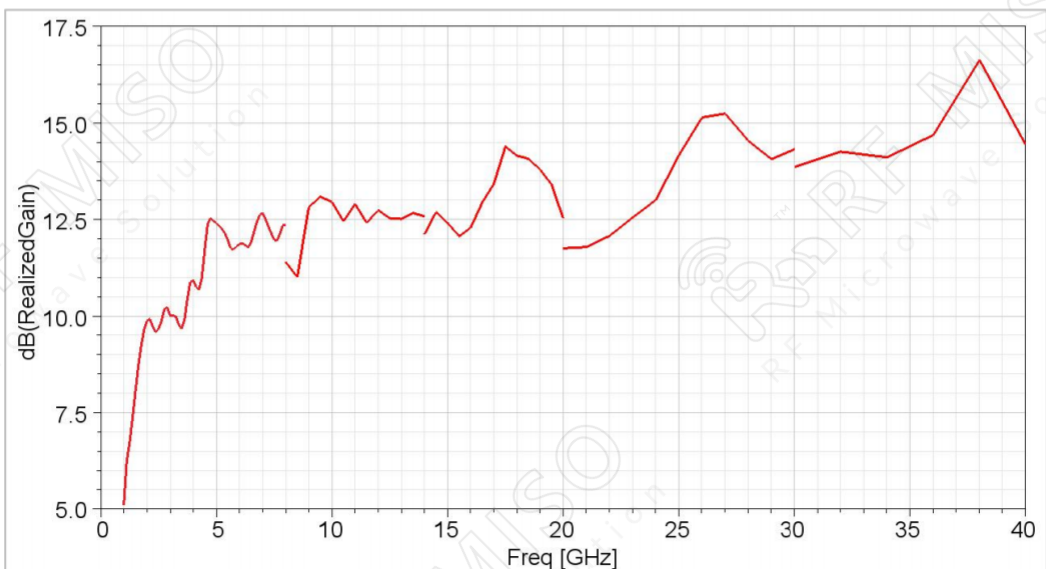

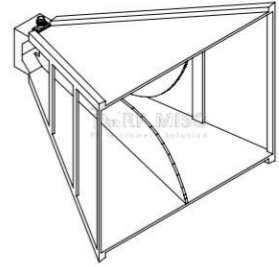

Broadband Horn Antenna  
12 dBi Typ. Gain, 1-40 GHz Frequency Range

**Broadband Horn Antenna Data Sheet**

**RM-BDHA140-12**

Gain Pattern

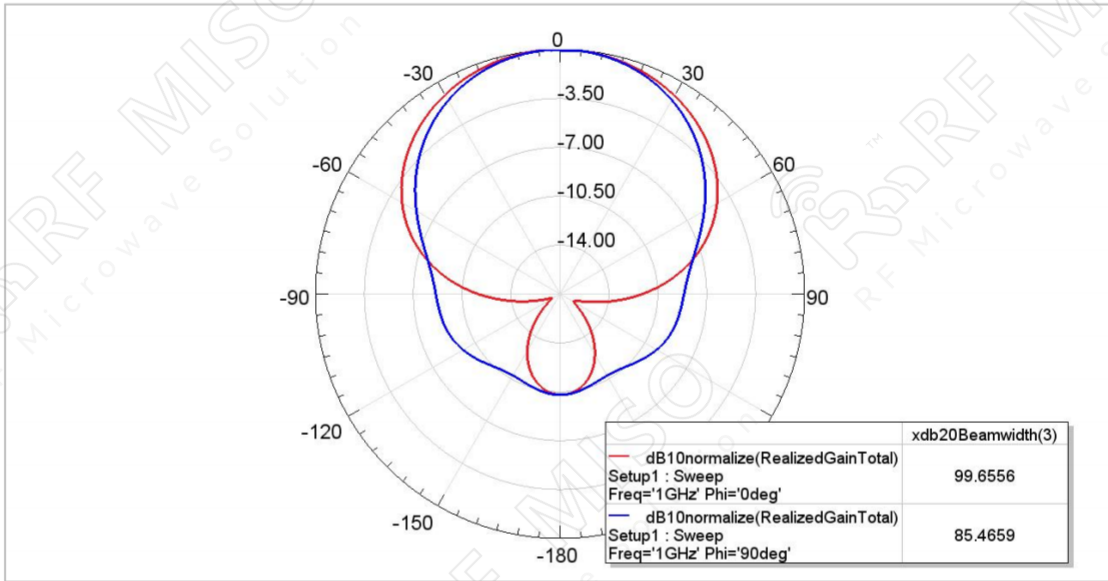

1 GHz

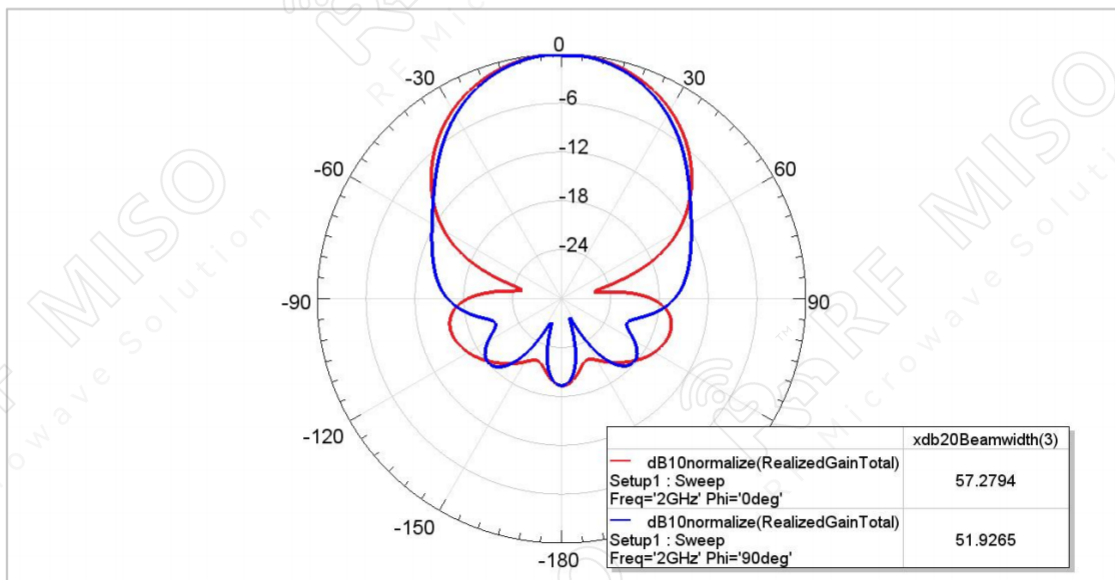

2 GHz

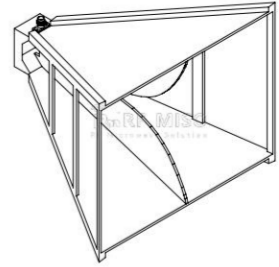

**Broadband Horn Antenna**  
12 dBi Typ. Gain, 1-40 GHz Frequency Range

**Broadband Horn Antenna Data Sheet**

**RM-BDHA140-12**

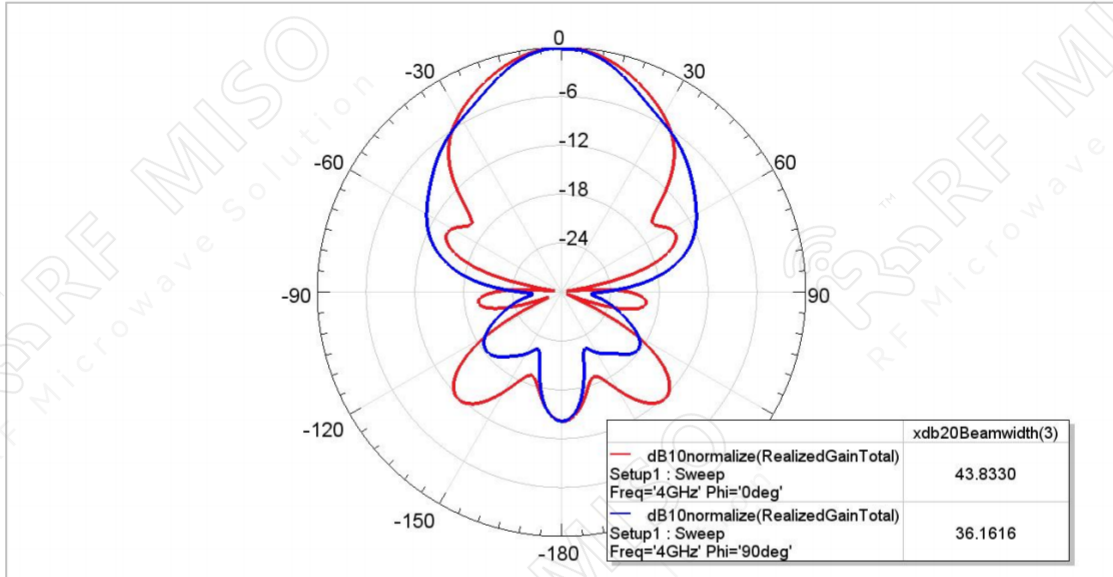

4 GHz

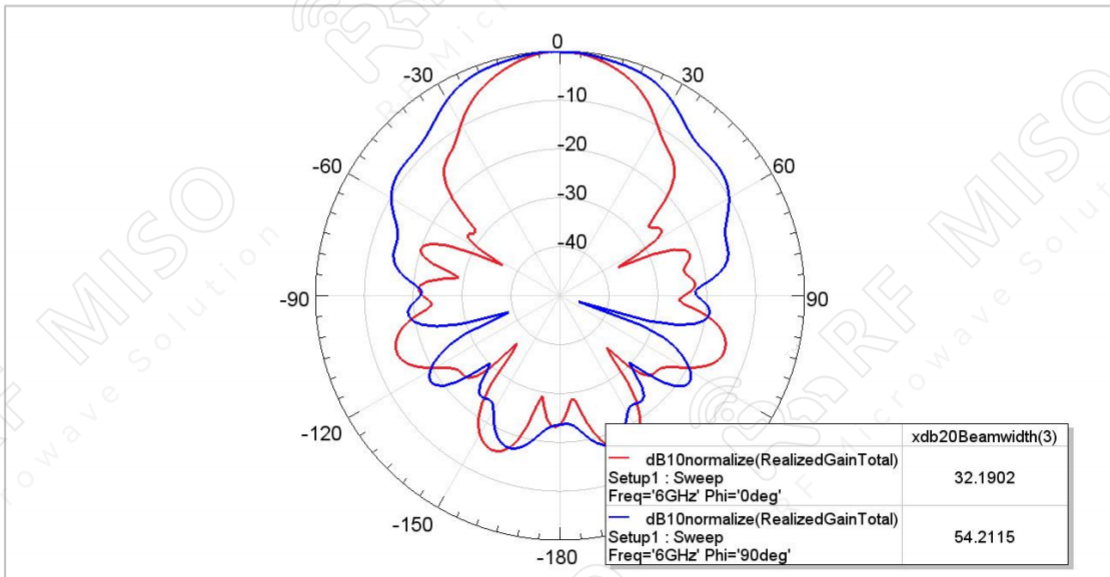

6 GHz



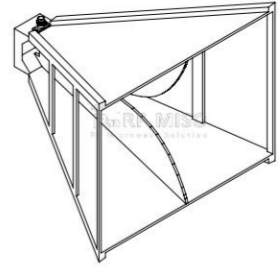

Broadband Horn Antenna  
12 dBi Typ. Gain, 1-40 GHz Frequency Range

**Broadband Horn Antenna Data Sheet**

**RM-BDHA140-12**

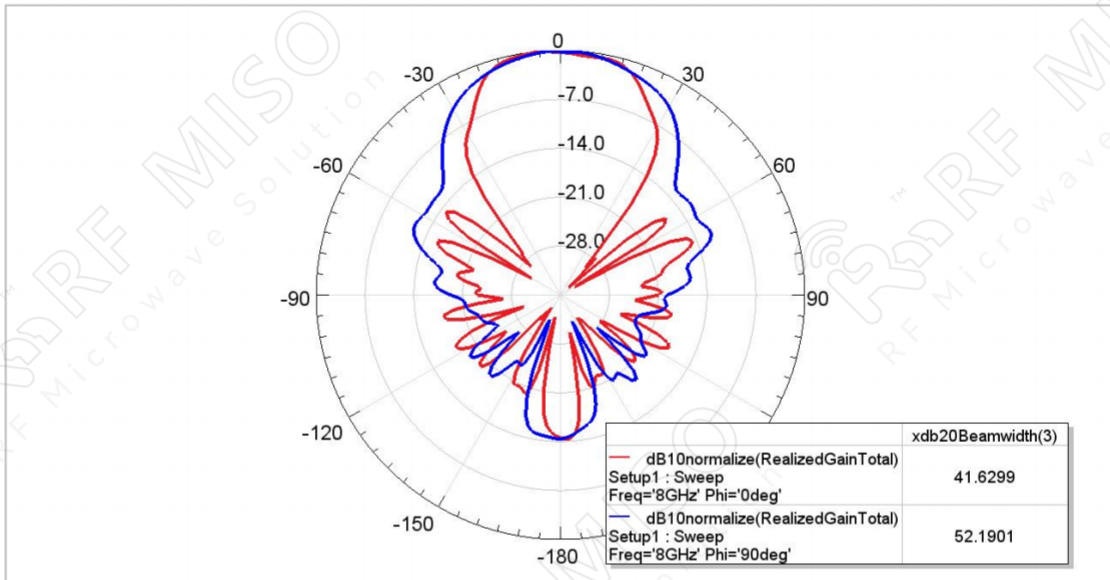

8 GHz

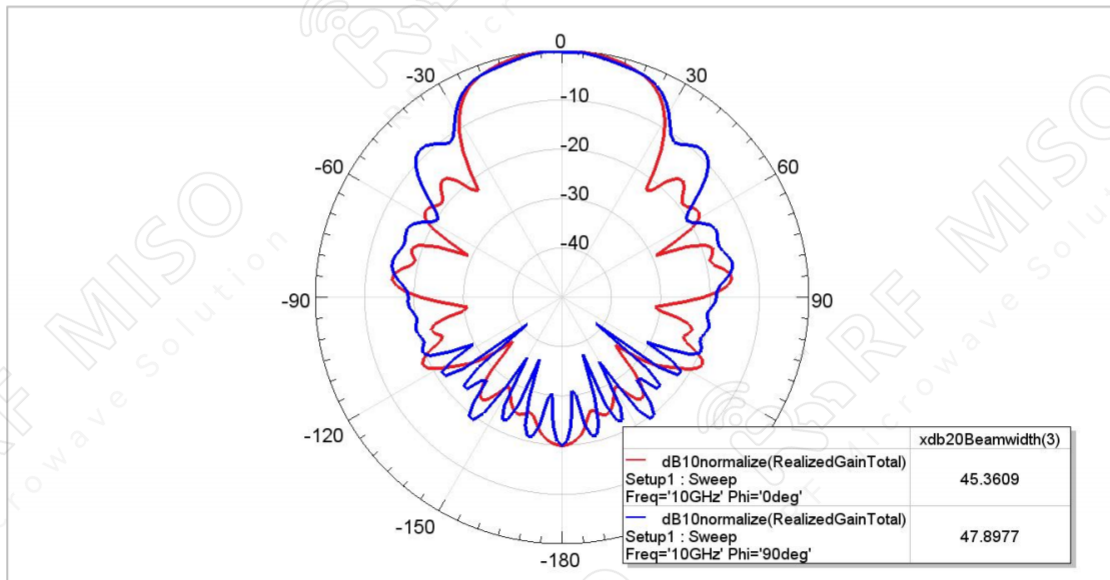

10 GHz

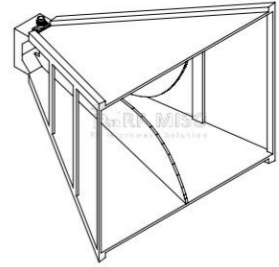

**Broadband Horn Antenna**  
12 dBi Typ. Gain, 1-40 GHz Frequency Range

**Broadband Horn Antenna Data Sheet**

**RM-BDHA140-12**

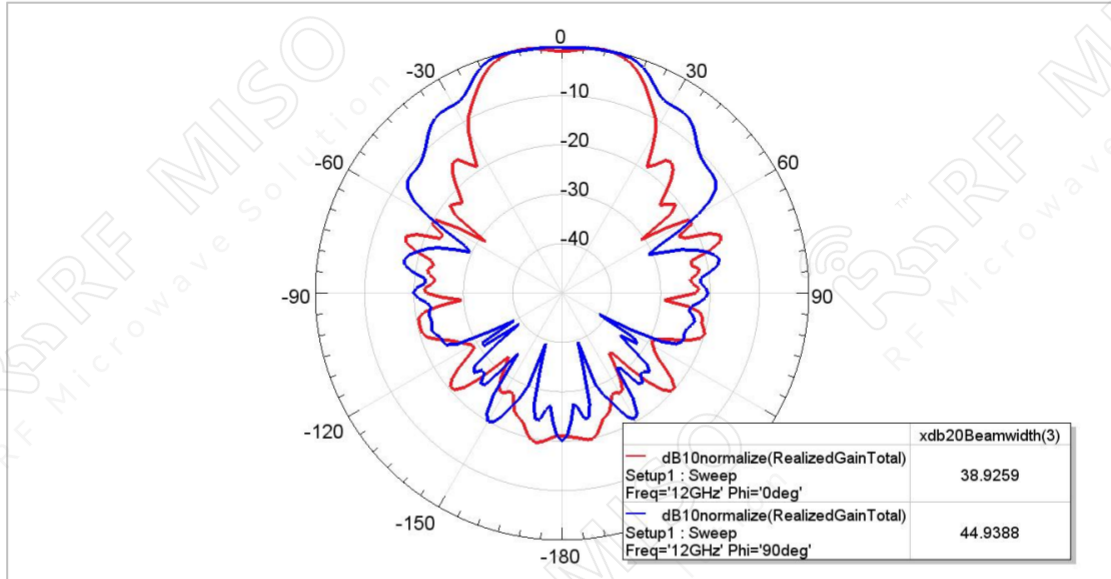

12 GHz

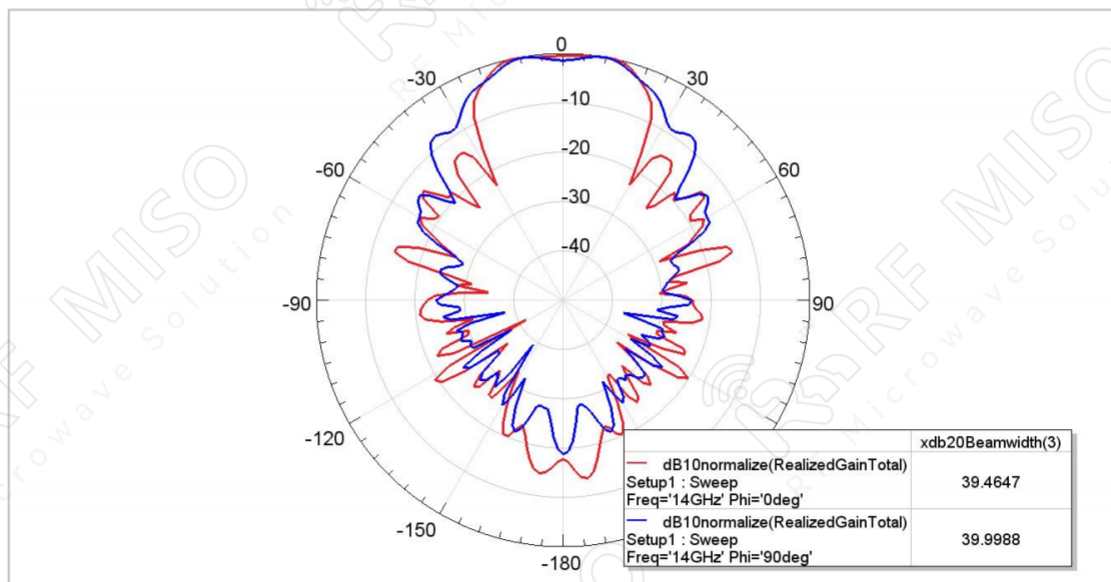

14 GHz

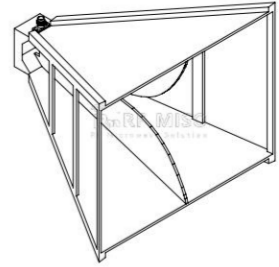

**Broadband Horn Antenna**  
12 dBi Typ. Gain, 1-40 GHz Frequency Range

**Broadband Horn Antenna Data Sheet**

**RM-BDHA140-12**

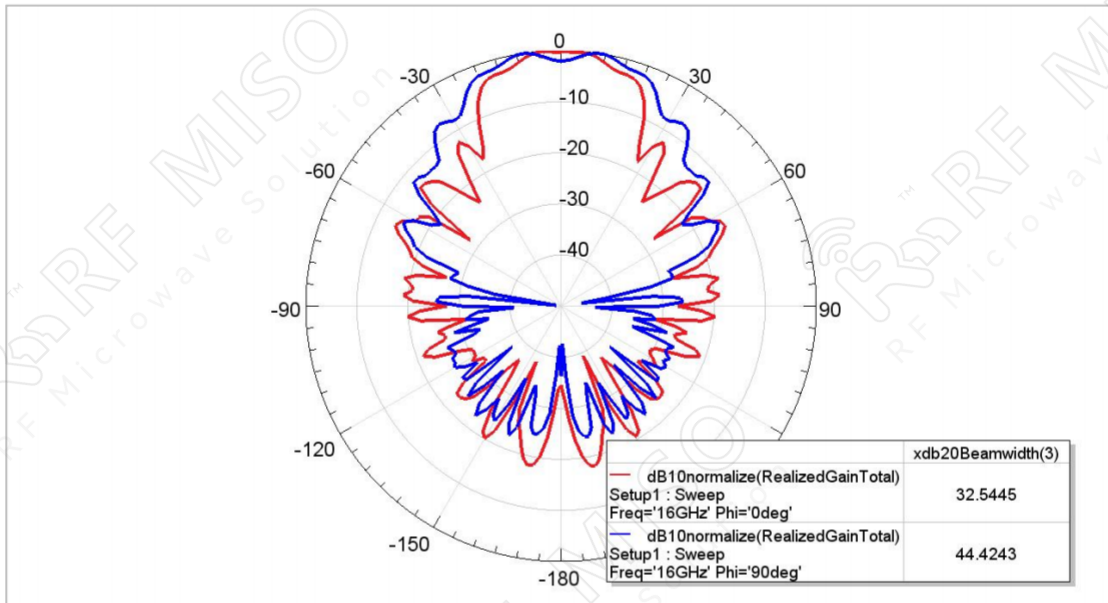

16 GHz

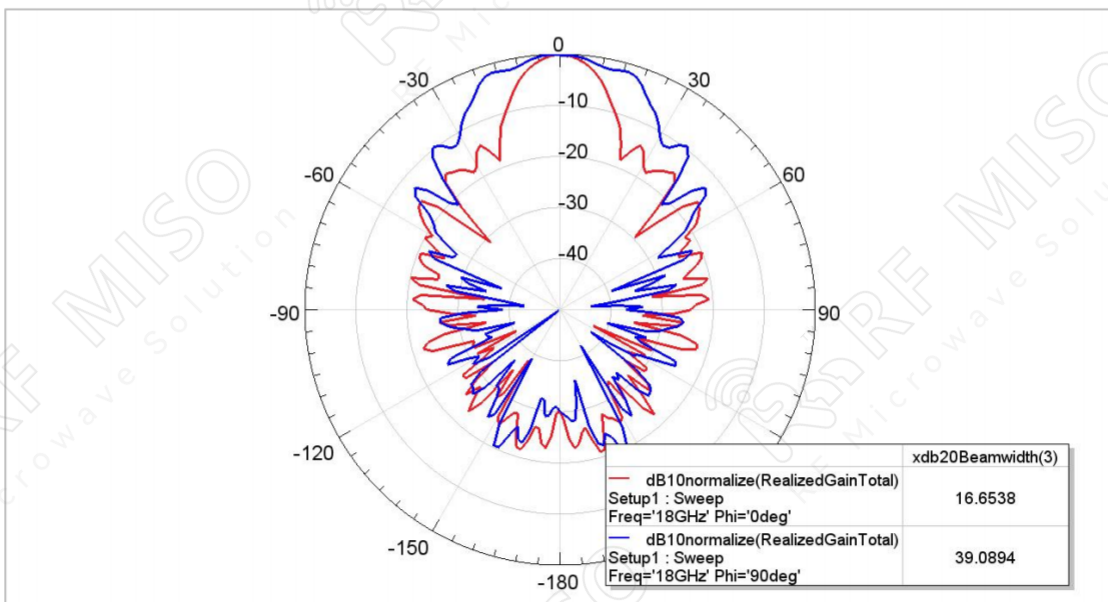

18 GHz



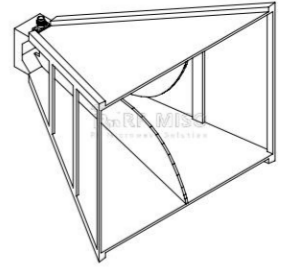

Broadband Horn Antenna  
12 dBi Typ. Gain, 1-40 GHz Frequency Range

**Broadband Horn Antenna Data Sheet**

**RM-BDHA140-12**

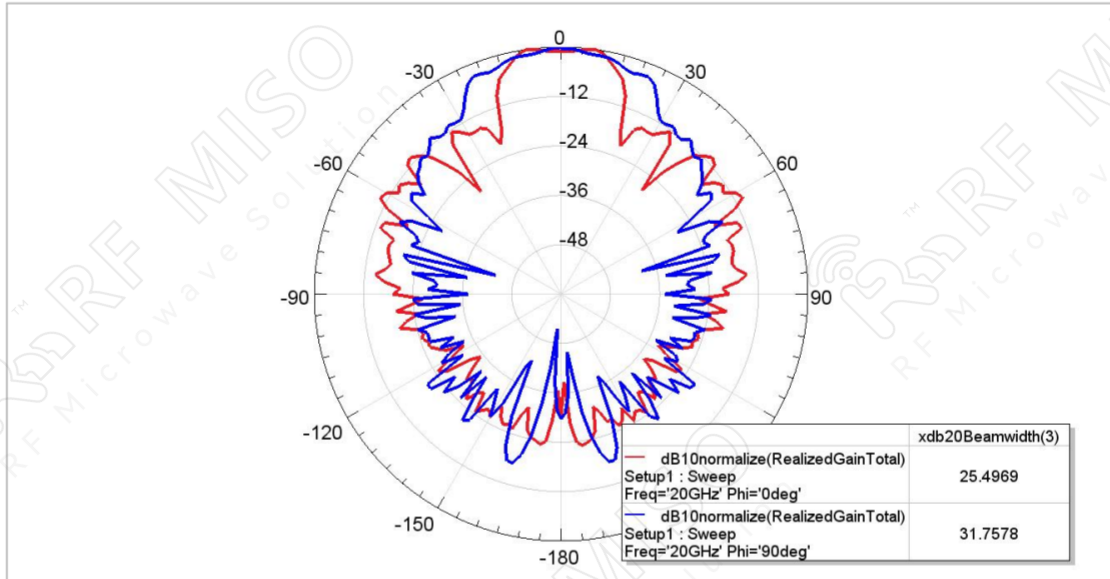

20 GHz

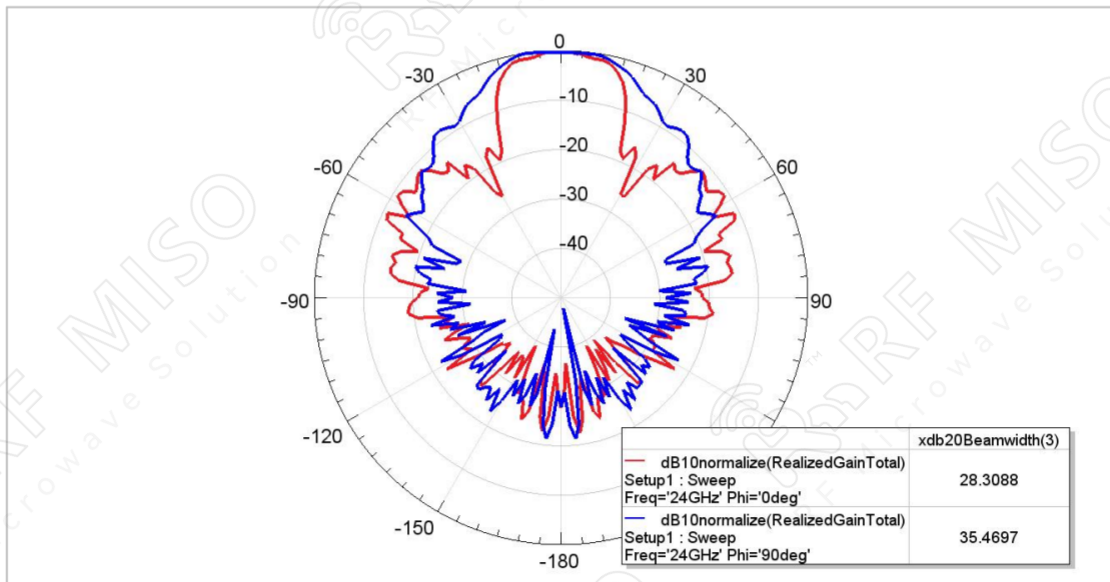

24 GHz

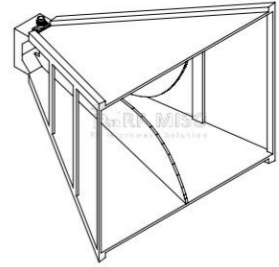

Broadband Horn Antenna  
12 dBi Typ. Gain, 1-40 GHz Frequency Range

**Broadband Horn Antenna Data Sheet**

**RM-BDHA140-12**

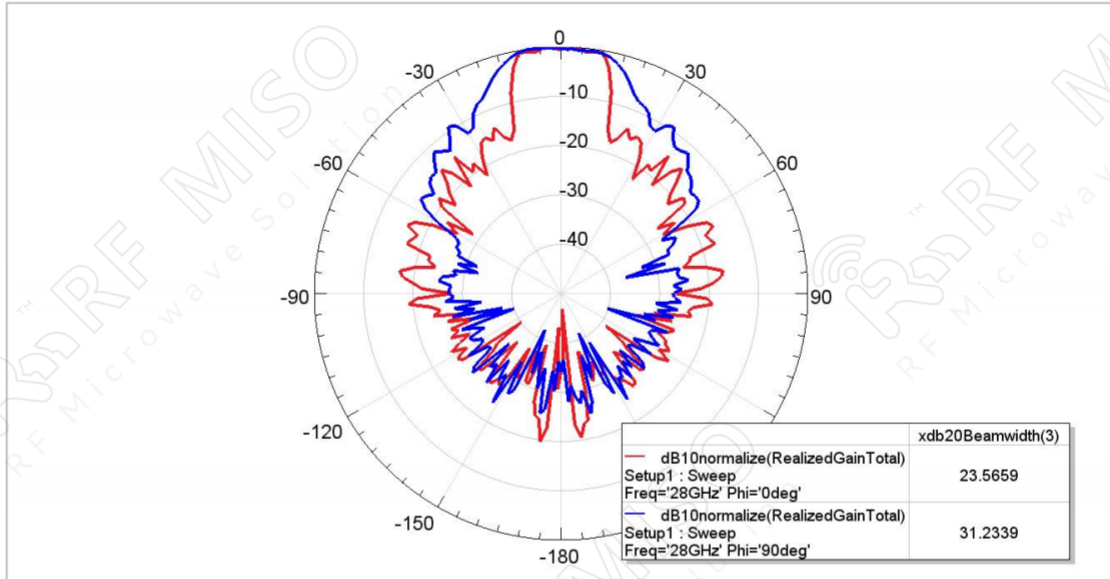

28 GHz

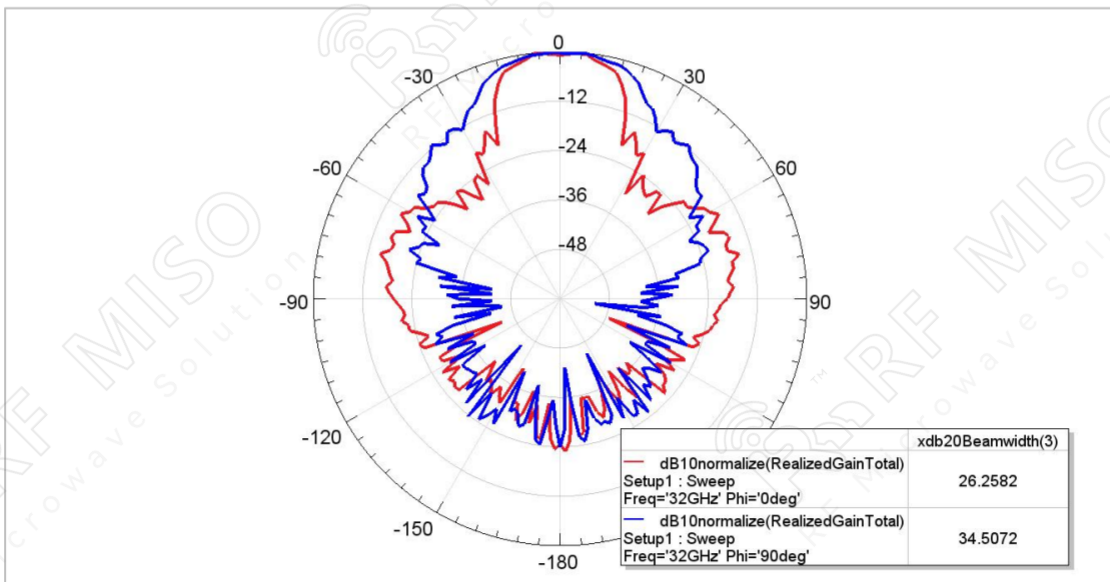

32 GHz

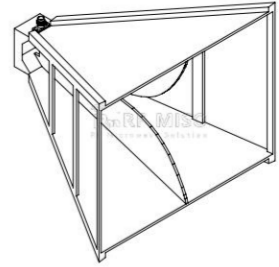

Broadband Horn Antenna  
12 dBi Typ. Gain, 1-40 GHz Frequency Range

**Broadband Horn Antenna Data Sheet**

**RM-BDHA140-12**

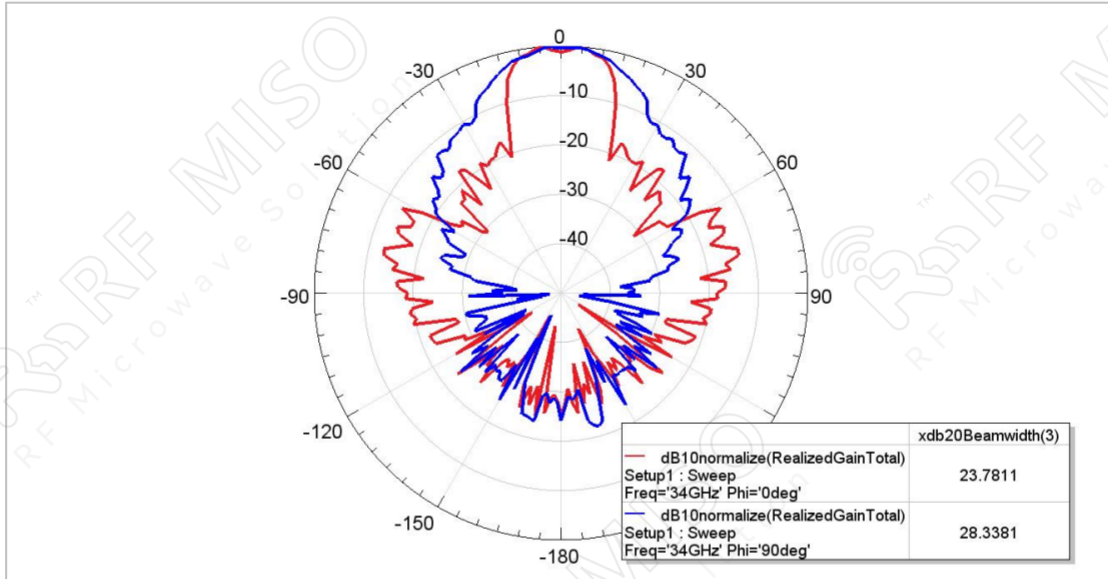

34 GHz

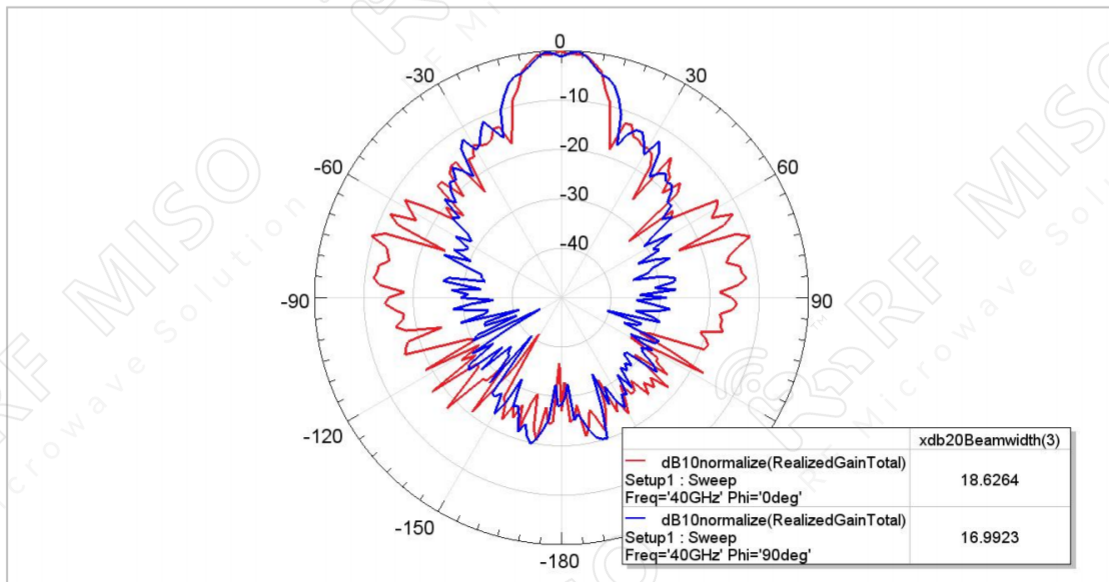

40 GHz