



Broadband Horn Antenna
13dBi Typ. Gain, 18-40GHz Frequency Range

Broadband Horn Antenna Data Sheet

RM-BDHA1840-13

Features

- Ideal for Antenna Measurements
- Linear Polarization
- Broadband Operation
- Small Size

Description

The **RM-BDHA1840-13** is a linear polarized broadband horn antenna that operates in the frequency range of 18GHz to 40GHz. The antenna offers a typical gain of 13dBi and VSWR 1.5:1 with 2.92-KFD connector. The antenna supports linear polarized waveforms. It is suitable for extensive applications such as EMC/EMI testing, surveillance, direction finding, as well as antenna gain and pattern measurements.

Specifications

RM-BDHA1840-13		
Item	Specification	Units
Frequency Range	18-40	GHz
Gain	13 Typ.	dBi
VSWR	1.5:1	
Polarization	Linear	
Cross Polarization Isolation	28	dB
Connector	2.92-KFD	
Finishing	Paint	
Material	Al	
Size	38.2*30.6*27.9(L*W*H)	mm



Broadband Horn Antenna
13dBi Typ. Gain, 18-40GHz Frequency Range

Broadband Horn Antenna Data Sheet

RM-BDHA1840-13

Outline Drawing

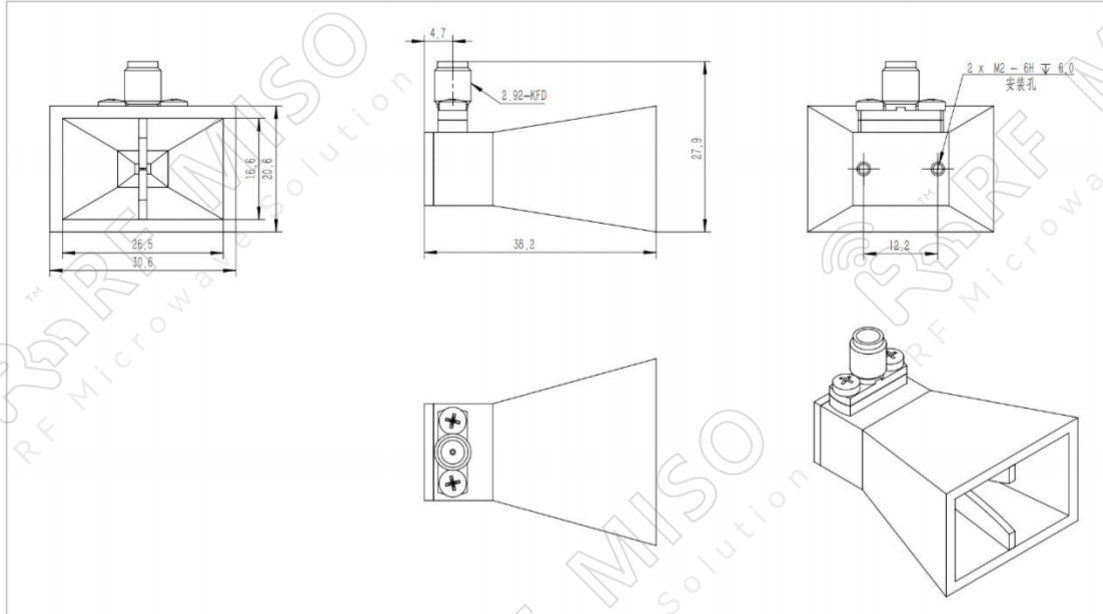

Test Results

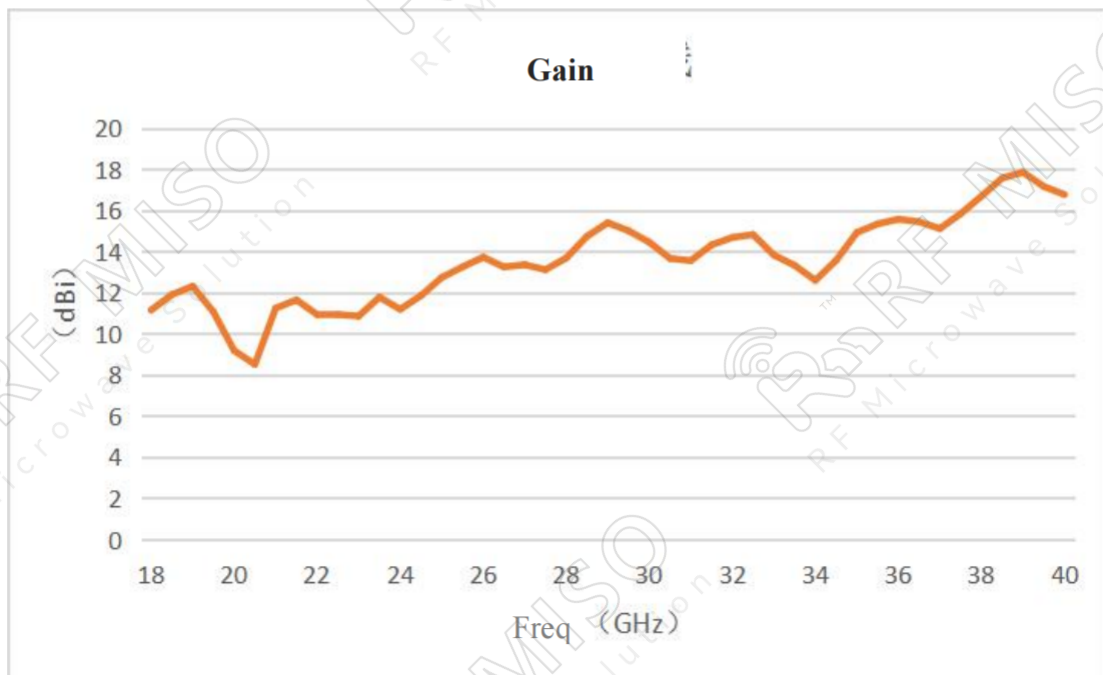

Broadband Horn Antenna
 13dBi Typ. Gain, 18-40GHz Frequency Range



Broadband Horn Antenna Data Sheet

RM-BDHA1840-13

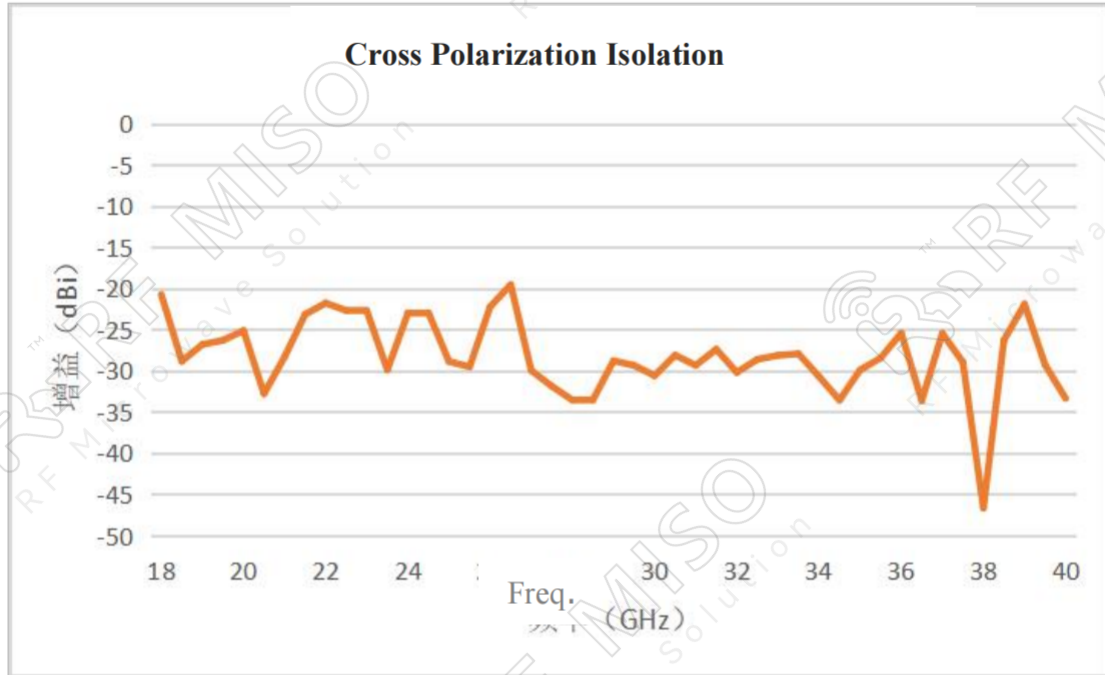

VSWR

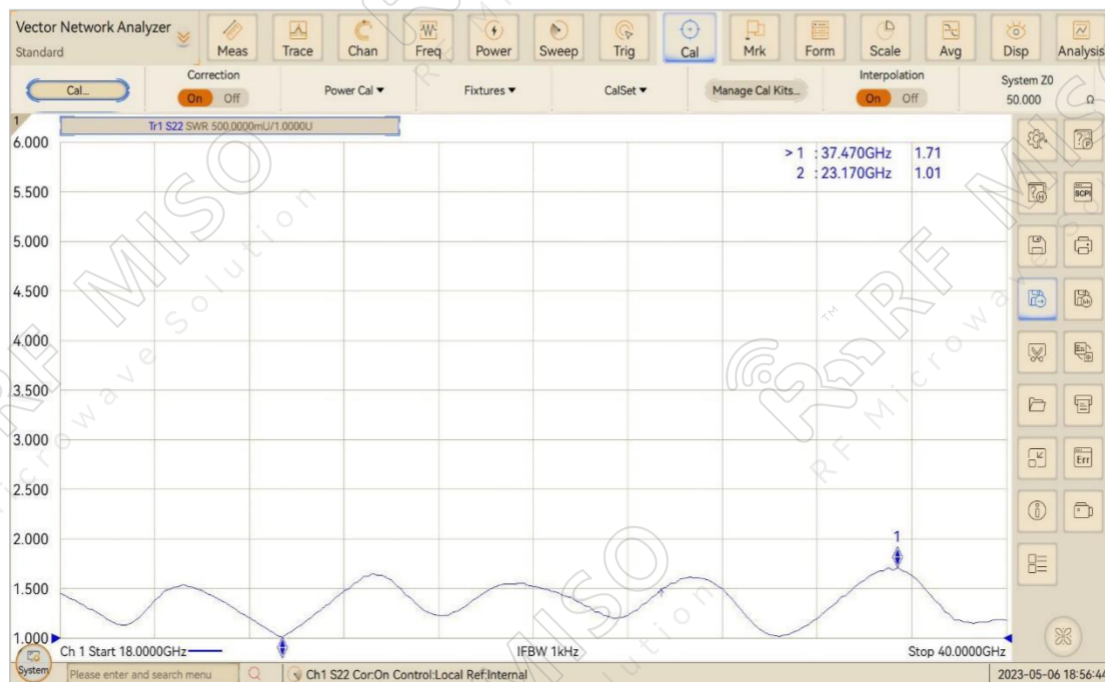



Broadband Horn Antenna
13dBi Typ. Gain, 18-40GHz Frequency Range

Broadband Horn Antenna Data Sheet

RM-BDHA1840-13

Pattern

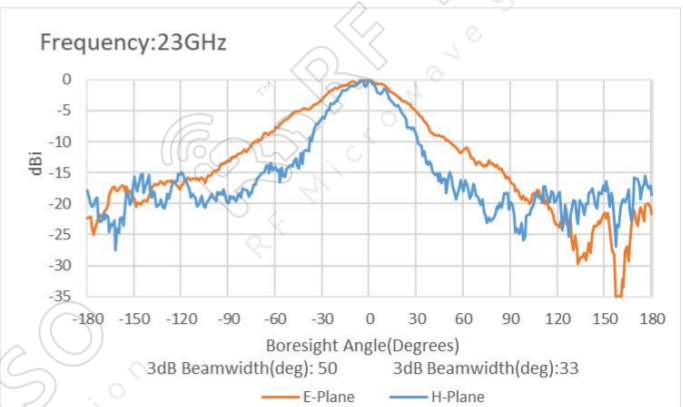
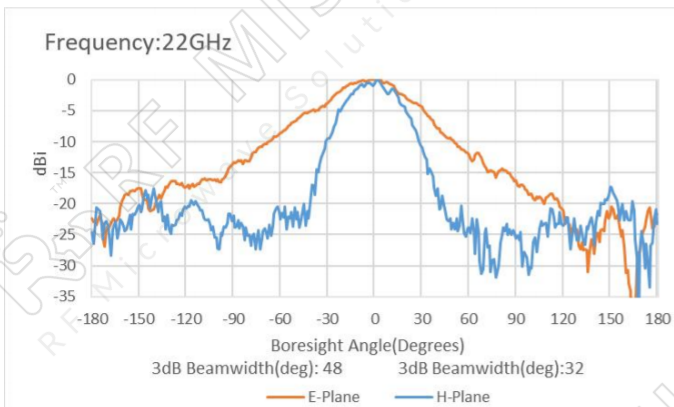
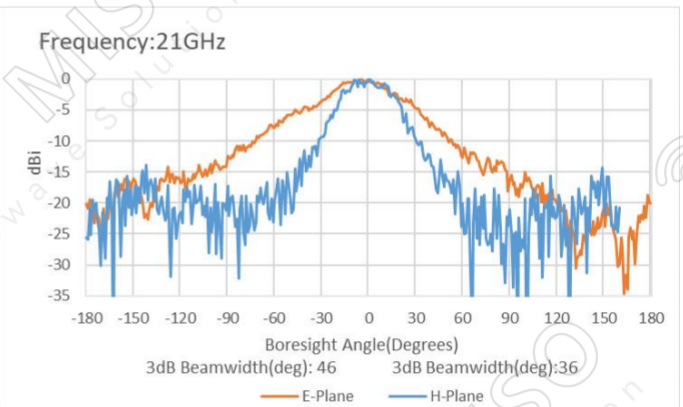
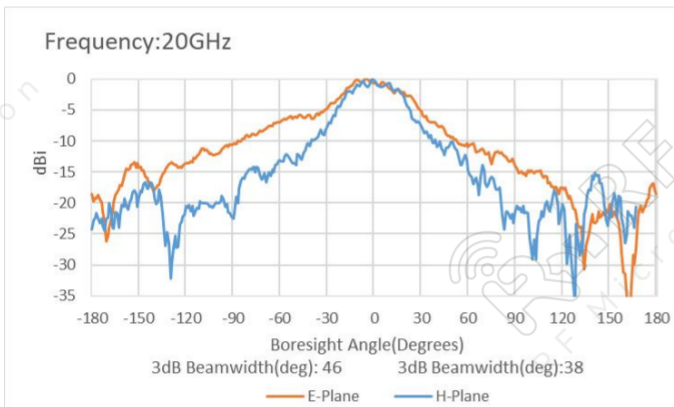
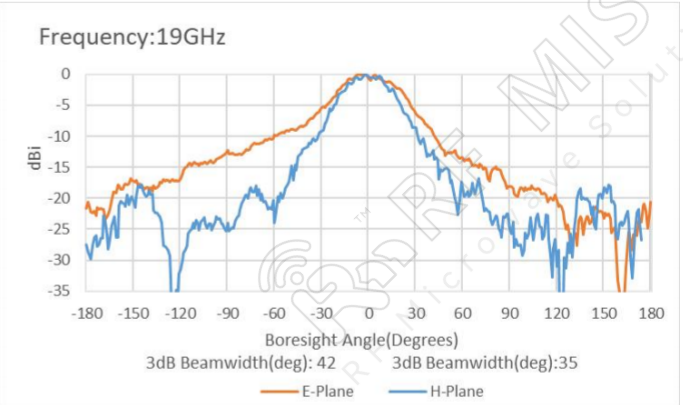
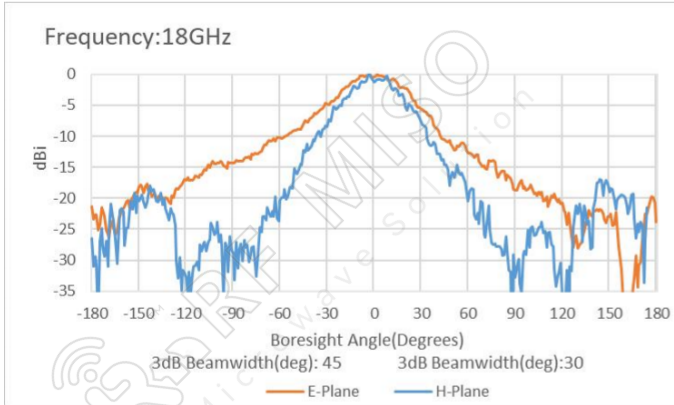



Broadband Horn Antenna
13dBi Typ. Gain, 18-40GHz Frequency Range

Broadband Horn Antenna Data Sheet

RM-BDHA1840-13

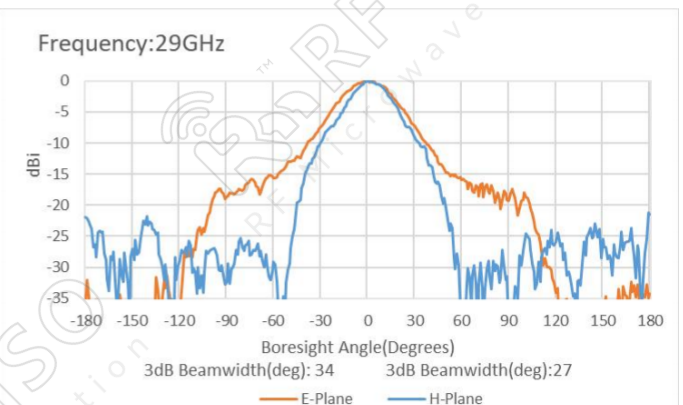
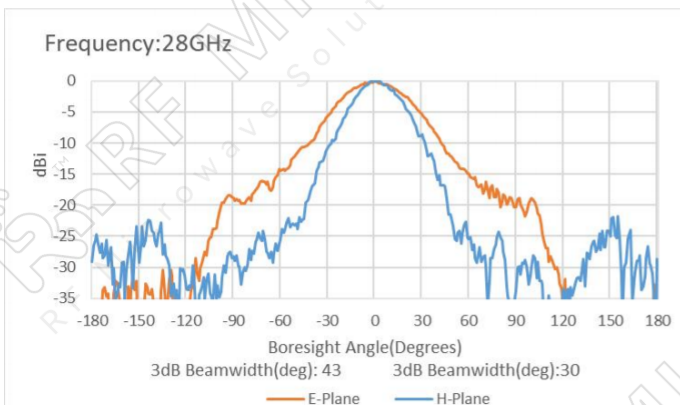
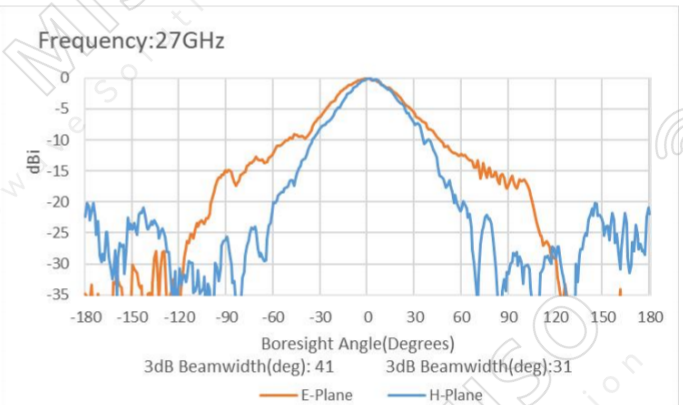
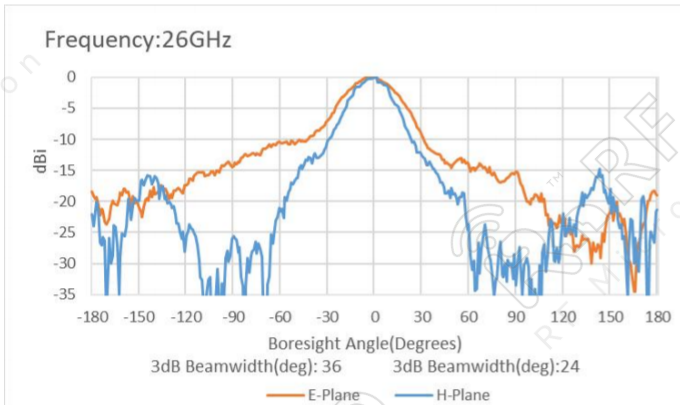
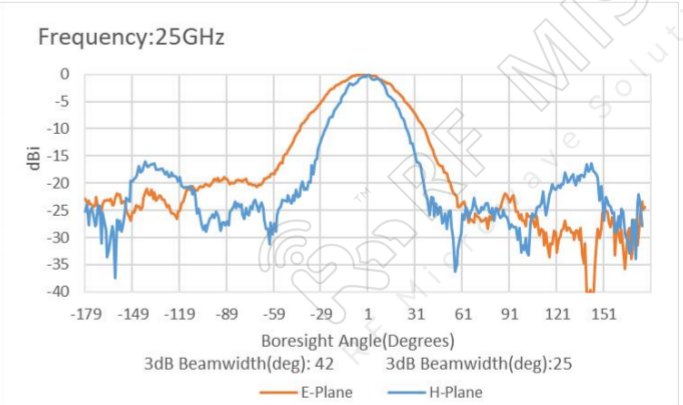
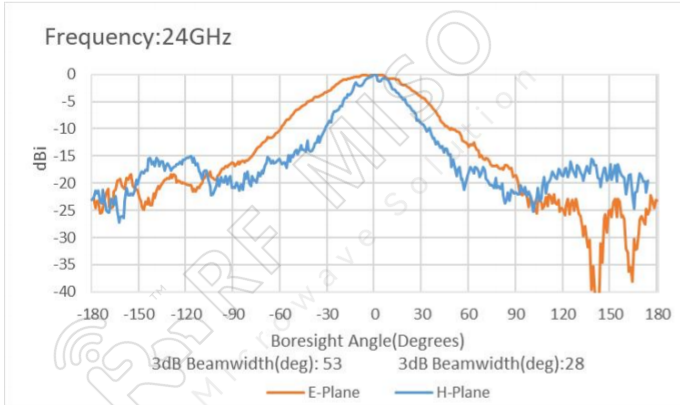



Broadband Horn Antenna
13dBi Typ. Gain, 18-40GHz Frequency Range

Broadband Horn Antenna Data Sheet

RM-BDHA1840-13

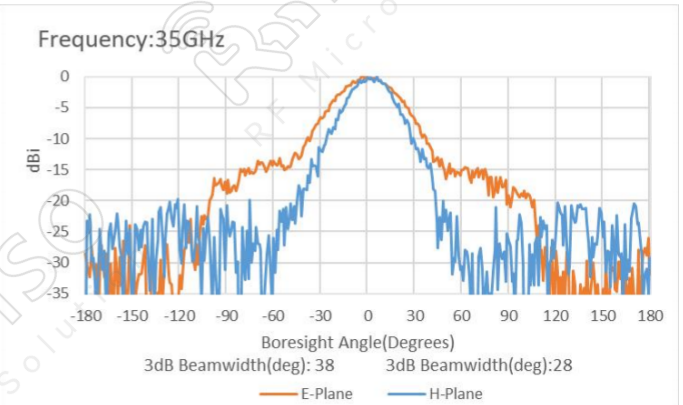
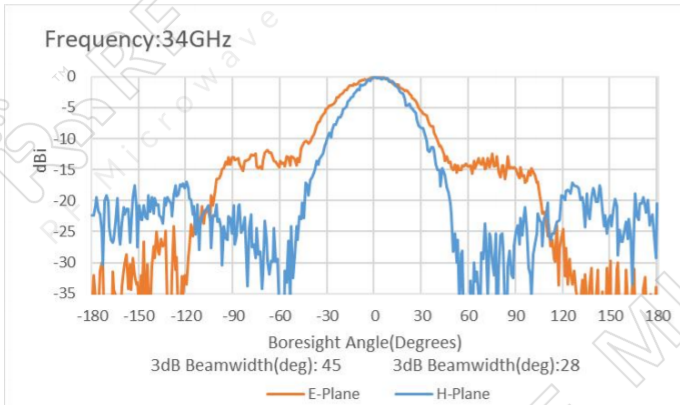
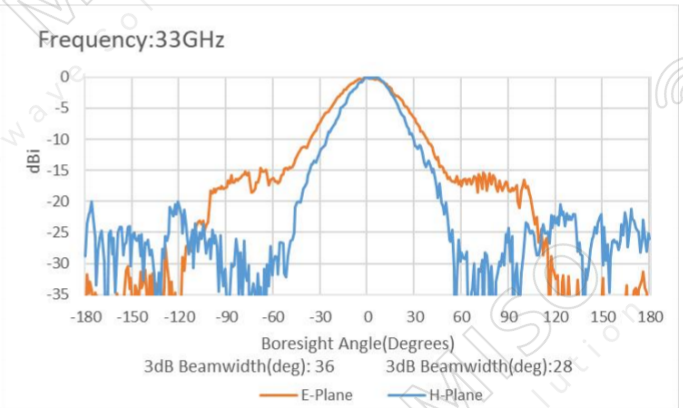
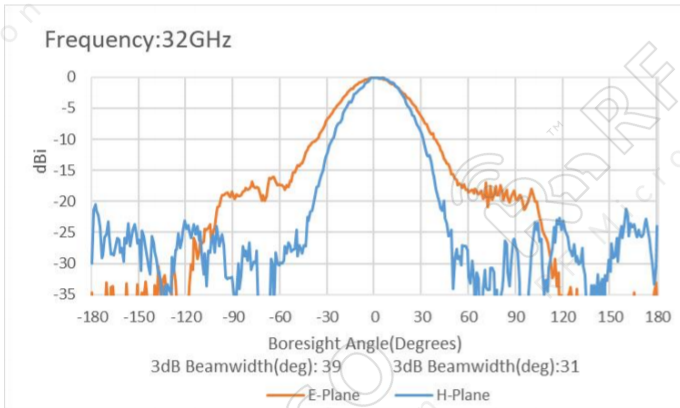
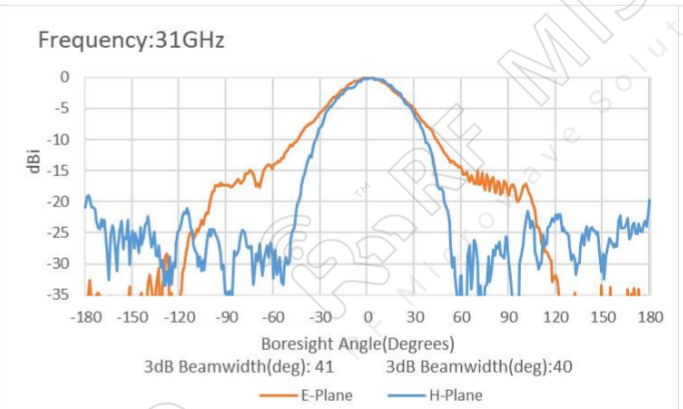
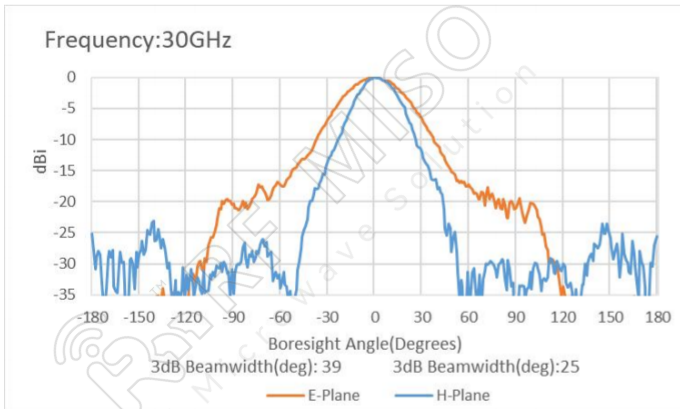



Broadband Horn Antenna
13dBi Typ. Gain, 18-40GHz Frequency Range

Broadband Horn Antenna Data Sheet

RM-BDHA1840-13

