

Broadband Horn Antenna 10 dBi Typ. Gain, 2.2-4.2 GHz
Frequency Range

Broadband Horn Antenna Data Sheet

RM-BDHA2242-10

Specifications

RM-BDHA2242-10		
Parameters	Typical	Units
Frequency Range	2.2-4.2	GHz
Gain	10 Typ.	dBi
VSWR	1.5 Typ.	
Polarization	Linear	
Material	Al	
Size(L*W*H)	136.9*128.5*112.06(±5)	mm
Weight	0.295	Kg

Outline Drawing

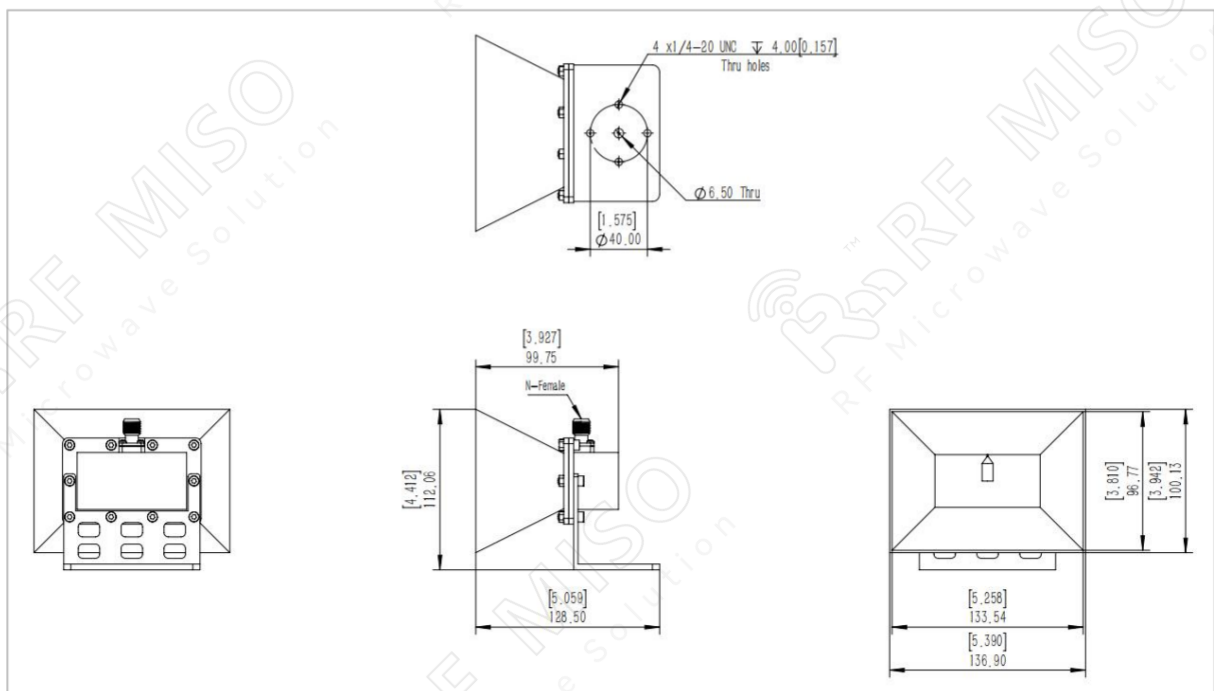

Broadband Horn Antenna 10 dBi Typ. Gain, 2.2-4.2 GHz
Frequency Range

Broadband Horn Antenna Data Sheet

RM-BDHA2242-10

Simulation Data

VSWR

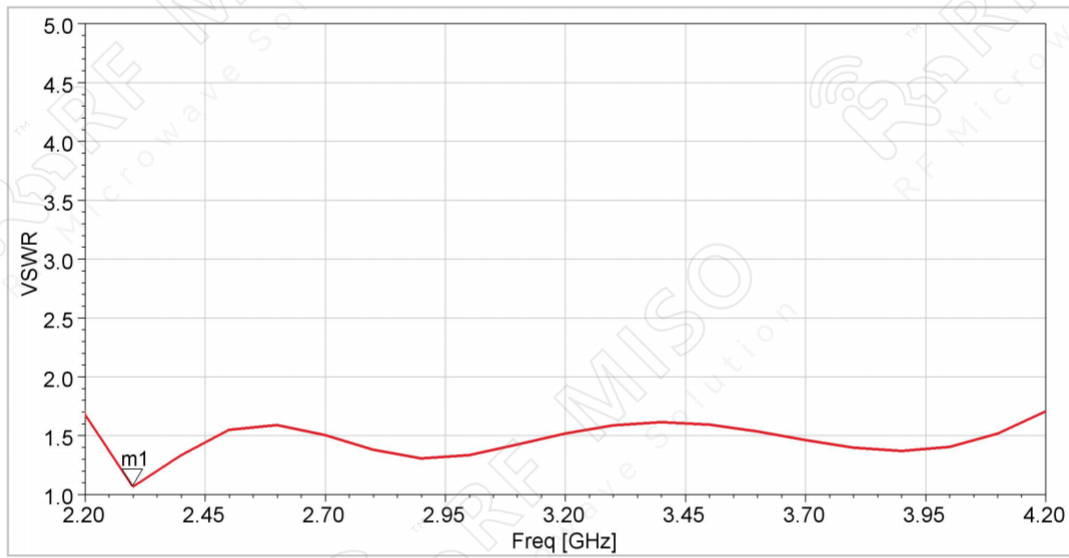

Gain

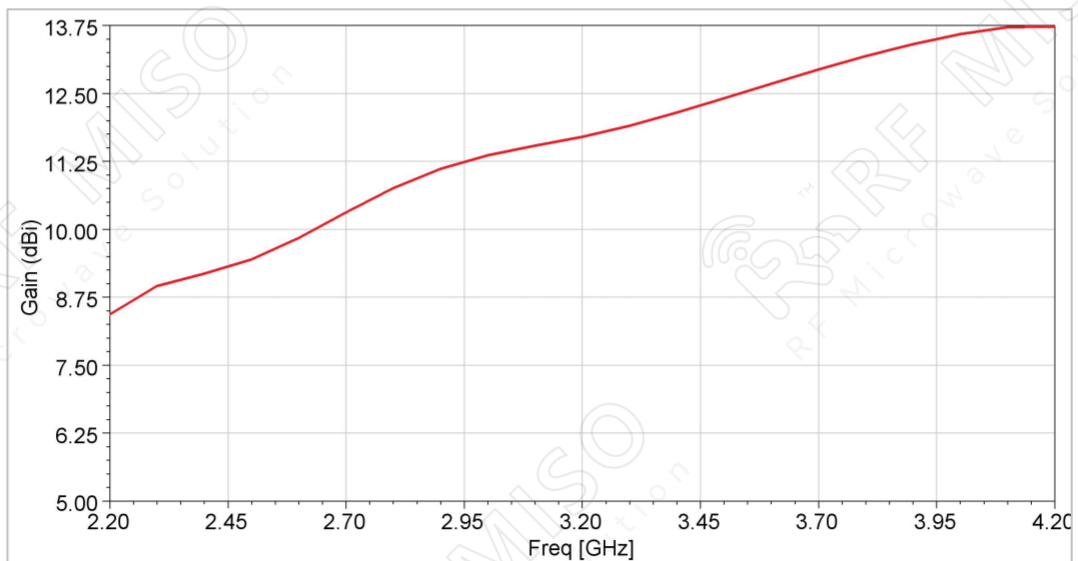

Broadband Horn Antenna 10 dBi Typ. Gain, 2.2-4.2 GHz
Frequency Range

Broadband Horn Antenna Data Sheet

RM-BDHA2242-10

Pattern

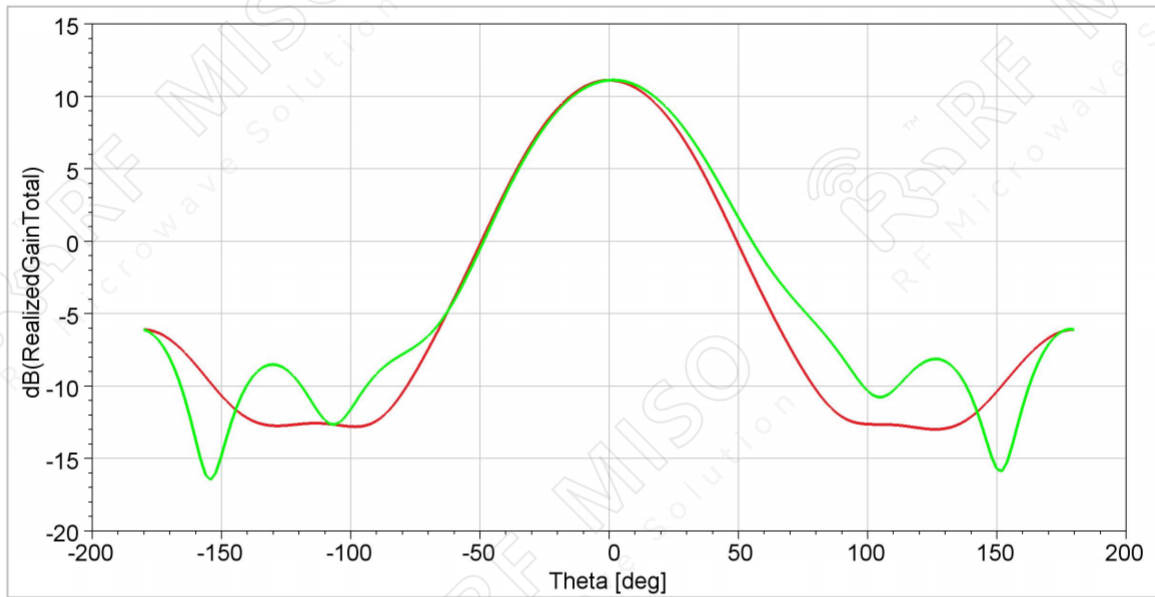

2.9GHz

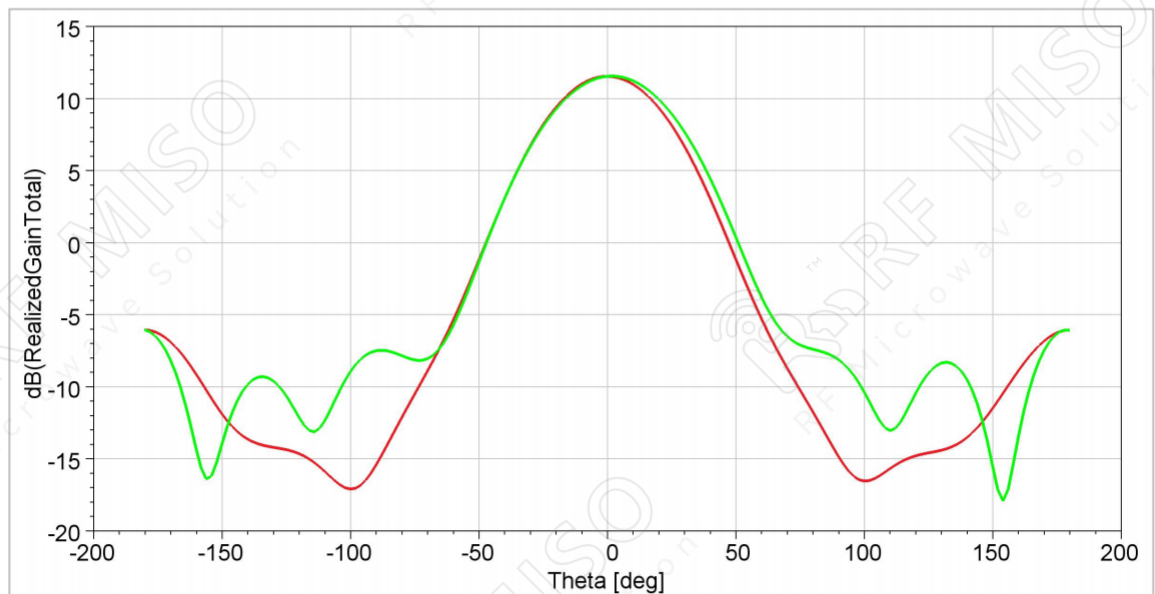

3.1GHz

Broadband Horn Antenna 10 dBi Typ. Gain, 2.2-4.2 GHz
Frequency Range

Broadband Horn Antenna Data Sheet

RM-BDHA2242-10

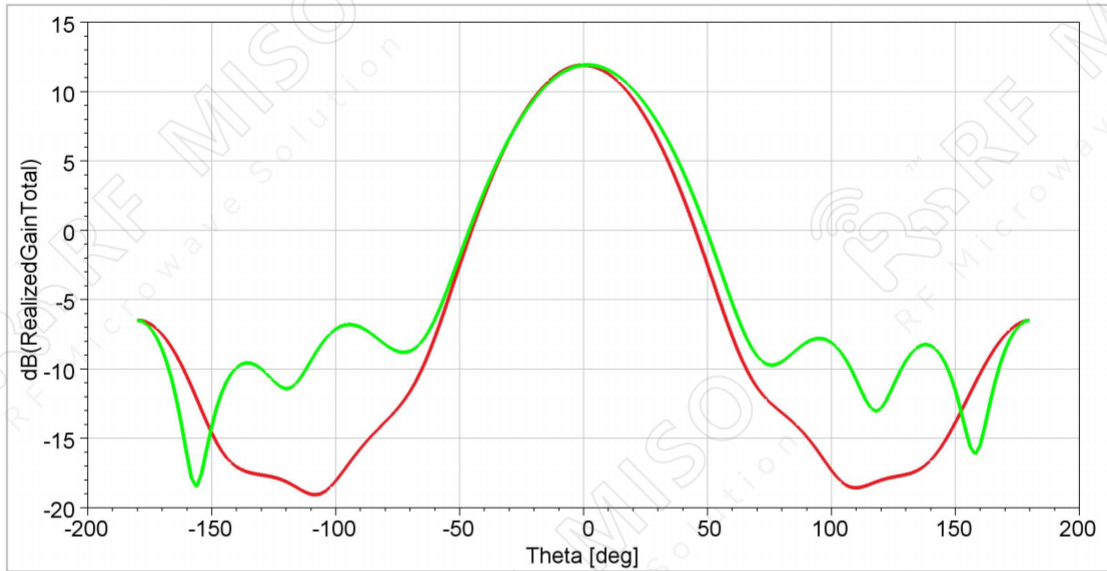

3.3GHz

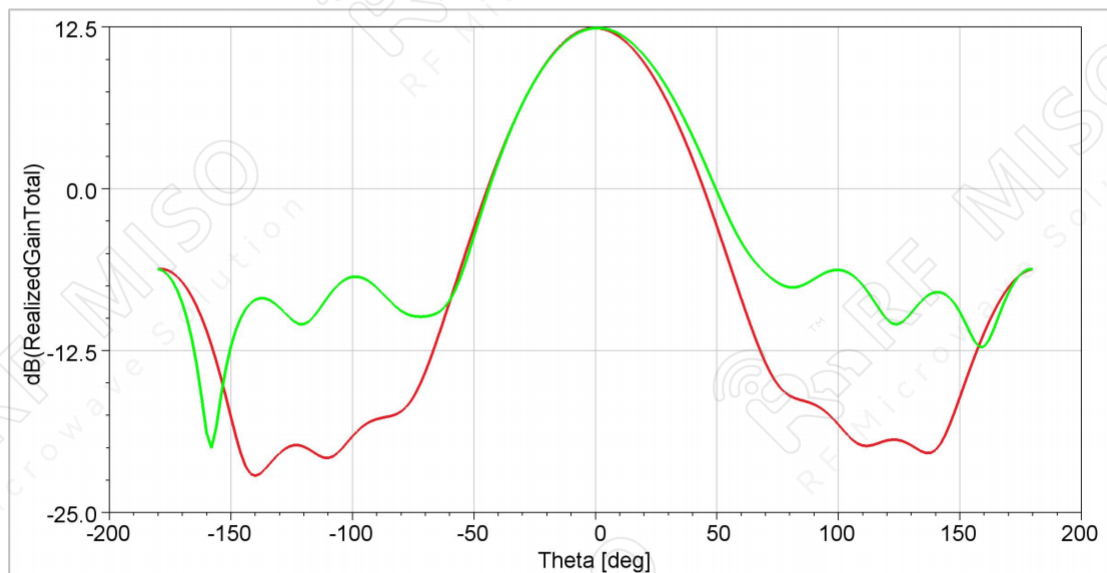

3.5GHz