

Broadband Horn Antenna Data Sheet

RM-BDHA618-10A

Features

- Ideal for Antenna Measurements
- Low VSWR
- Moderate Gain
- Broadband Operation
- Linear Polarization
- Small Size

Descriptions

RF MISO's **Model RM-BDHA618-10A** is a linear polarized double ridge horn antenna that operates from 6 to 18 GHz. The antenna offers a typical gain of 10 dBi and low VSWR 1.5:1 with SMA-KFD connector. The antenna is used for long time trouble-free applications in indoor and outdoor environments. It can be widely used in EMI detection, orientation, reconnaissance, antenna gain and pattern measurement and other applications.

Specifications

RM-BDHA618-10A		
Parameters	Typical	Units
Frequency Range	6-18	GHz
Gain	10 Typ.	dBi
VSWR	1.5 Typ.	
Polarization	Linear	
Connector	SMA-KFD	
Power	50 Max	CW
Material	Al	
Surface Treatment	Paint	
Size	52.2*54*38(L*W*H)	mm
Weight	50	g

Broadband Horn Antenna
10 dBi Typ. Gain, 6-18 GHz Frequency Range

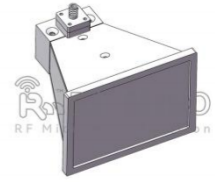

Broadband Horn Antenna Data Sheet

RM-BDHA618-10A

Outline Drawing

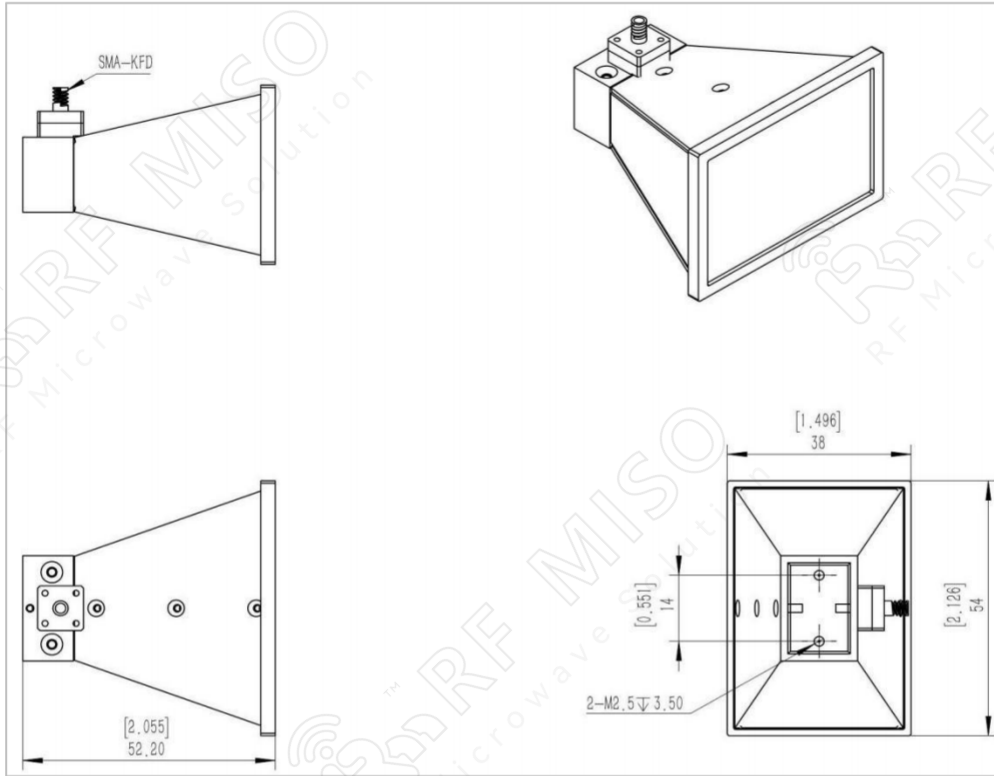

Test Result

VSWR



Broadband Horn Antenna
10 dBi Typ. Gain, 6-18 GHz Frequency Range

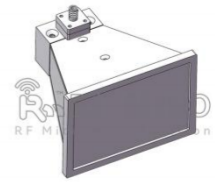

Broadband Horn Antenna Data Sheet

RM-BDHA618-10A

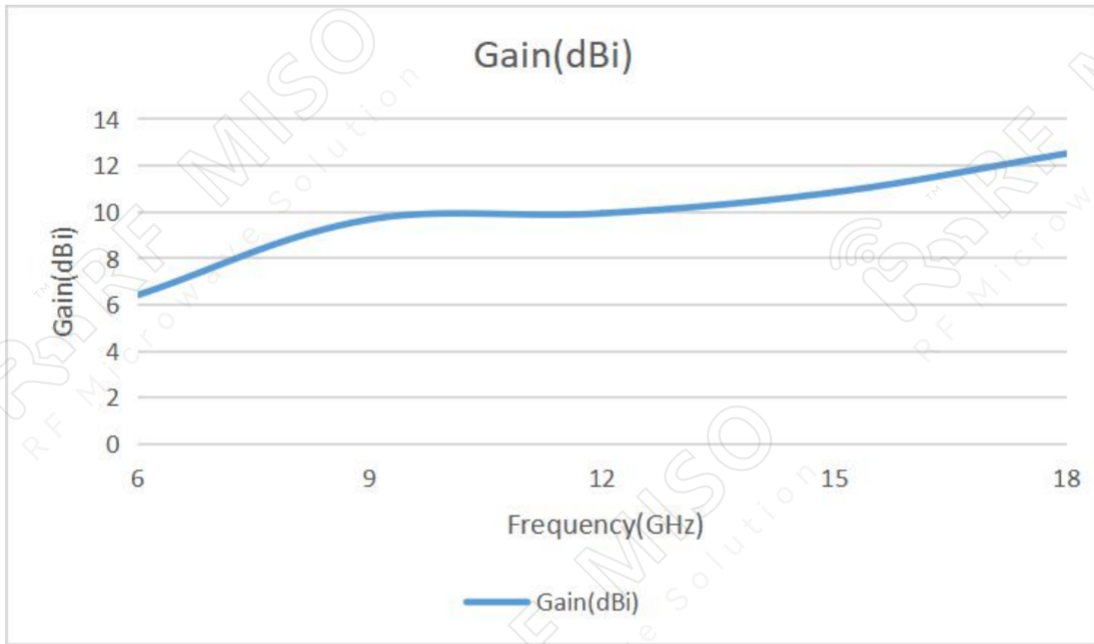

Gain Pattern

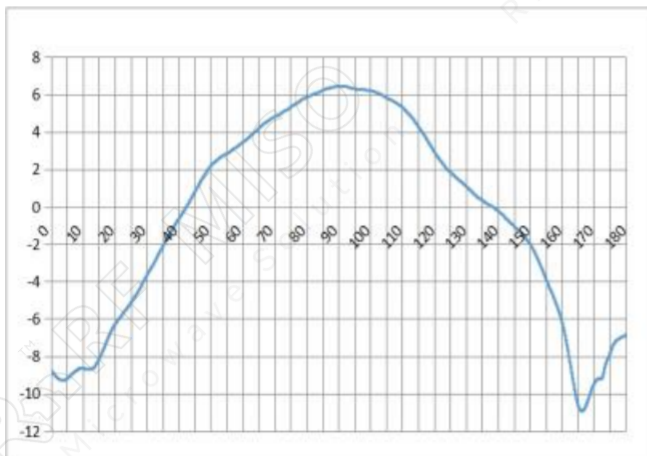

6GHz

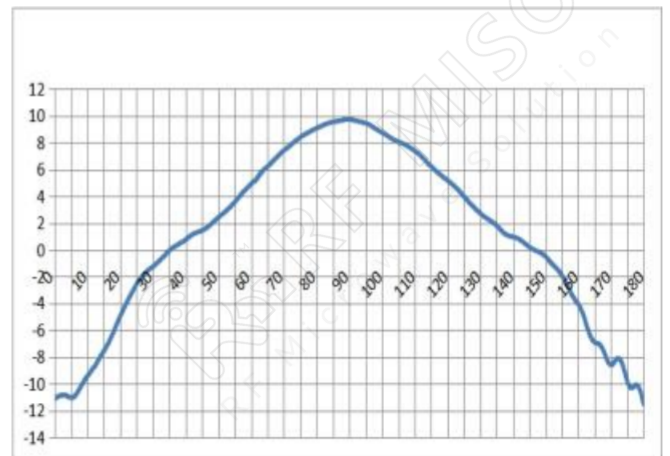

9GHz

Broadband Horn Antenna
10 dBi Typ. Gain, 6-18 GHz Frequency Range

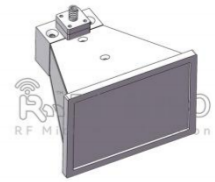

Broadband Horn Antenna Data Sheet

RM-BDHA618-10A

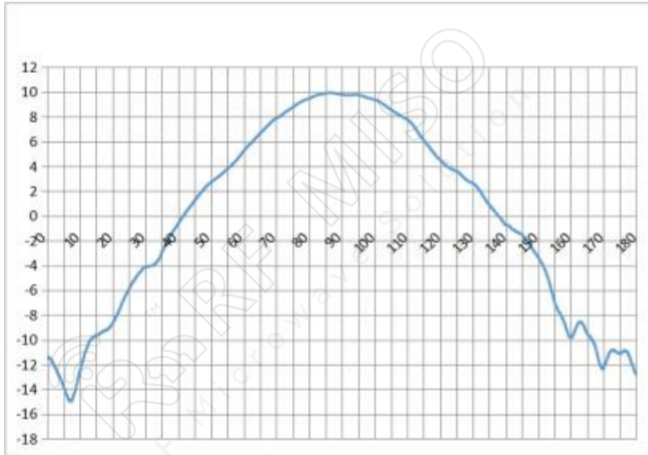

12GHz

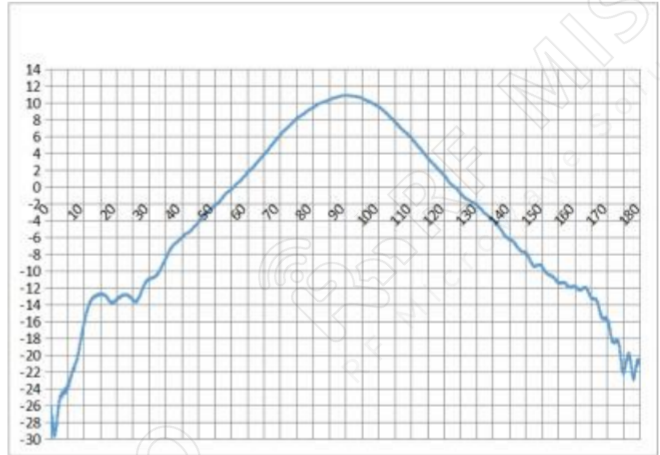

15GHz

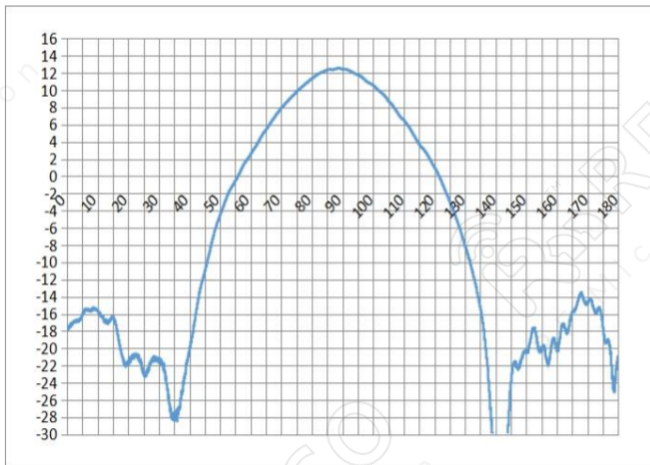

18GHz