



*Circularly Polarized Horn Antenna 12dBi Typ. Gain,
18-40 GHz Frequency Range*

Circularly Polarized Horn Antenna Data Sheet

Features

- Low VSWR
- High Power handling
- Symmetrical Plane Beamwidth
- RHCP or LHCP
- Military Airborne Applications

Descriptions

RF MISO' s Model RM-CPHA1840-12 is RHCP or LHCP circularly polarized horn antenna that operates from 18 to 40GHz. The antenna offers a typical gain of 12 dBi and low VSWR 1.5 Typ.

The antenna is equipped with a circular polarizer, a circular waveguide to circular waveguide Converter and a conical horn antenna. The gain of the antenna is uniform in the entire frequency band, the pattern is symmetrical, and the working efficiency is high. Antennas are widely used in antenna far-field testing, radio frequency radiation testing and other scenarios.

Specifications

RM-CPHA1840-12		
Parameters	Specification	Unit
Frequency Range	18-40	GHz
Gain	12 Typ.	dBi
VSWR	1.5 Typ.	
AR	2 Typ	dB
Polarization	RHCP or LHCP	
Interface	2.92-Female	
Material	Al	
Finishing	Paint	
Average Power	20	W
Peak Power	40	W
Size (L*W*H)	105.7*17.9*38 (±5)	mm
Weight	0.049	kg



RM-CPHA1840-12

*Circularly Polarized Horn Antenna 12dBi Typ. Gain,
18-40 GHz Frequency Range*

Circularly Polarized Horn Antenna Data Sheet

Outline Drawing

N type and SMA type connectors are available, please contact RF Miso.

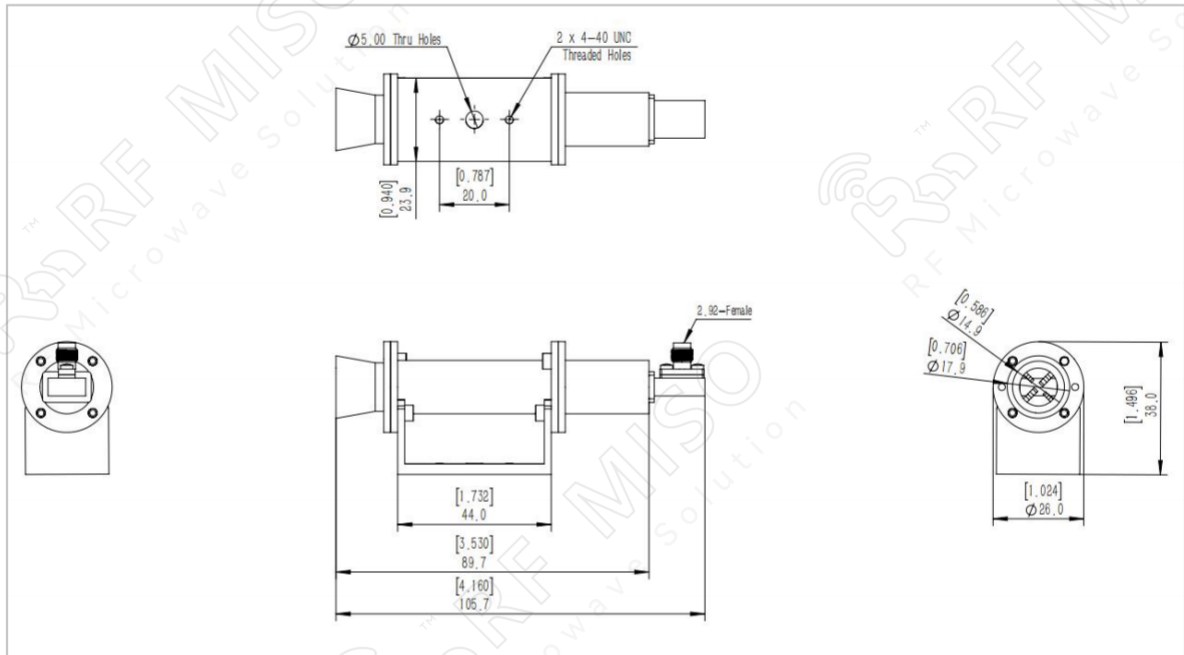

Simulation Data

Gain

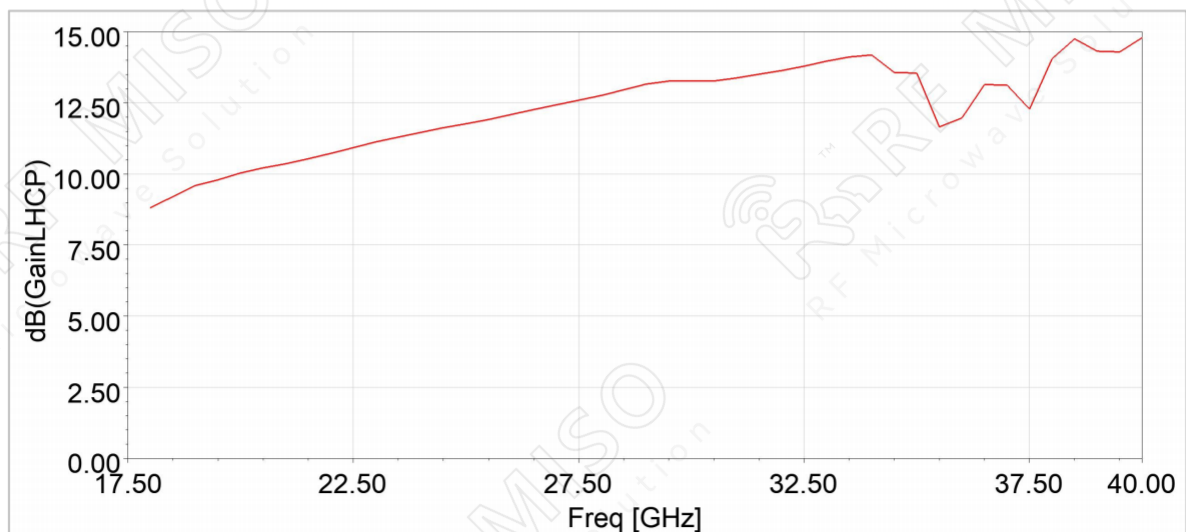



RM-CPHA1840-12

*Circularly Polarized Horn Antenna 12dBi Typ. Gain,
18-40 GHz Frequency Range*

Circularly Polarized Horn Antenna Data Sheet

VSWR

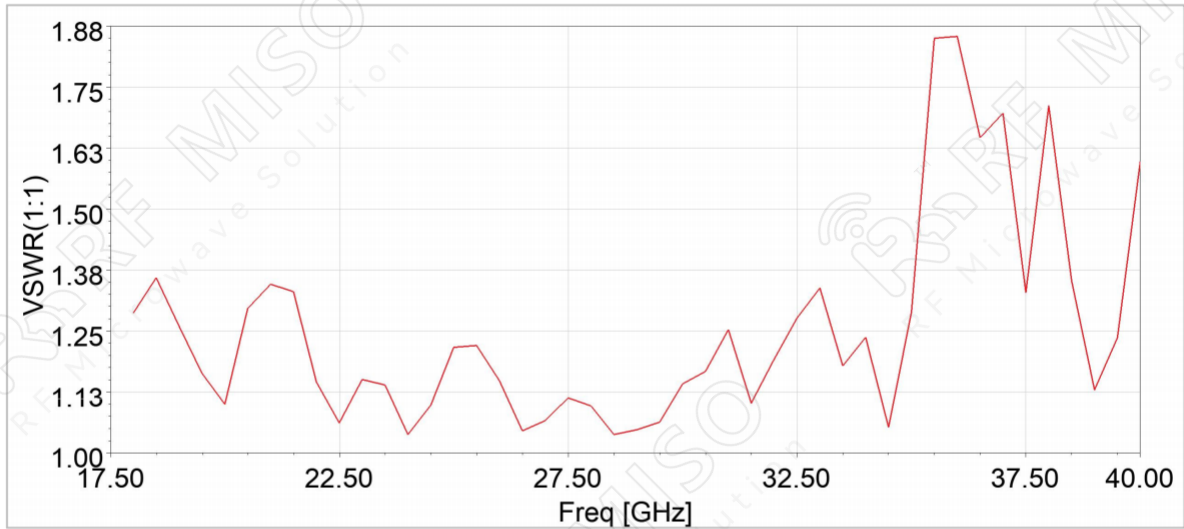

AR

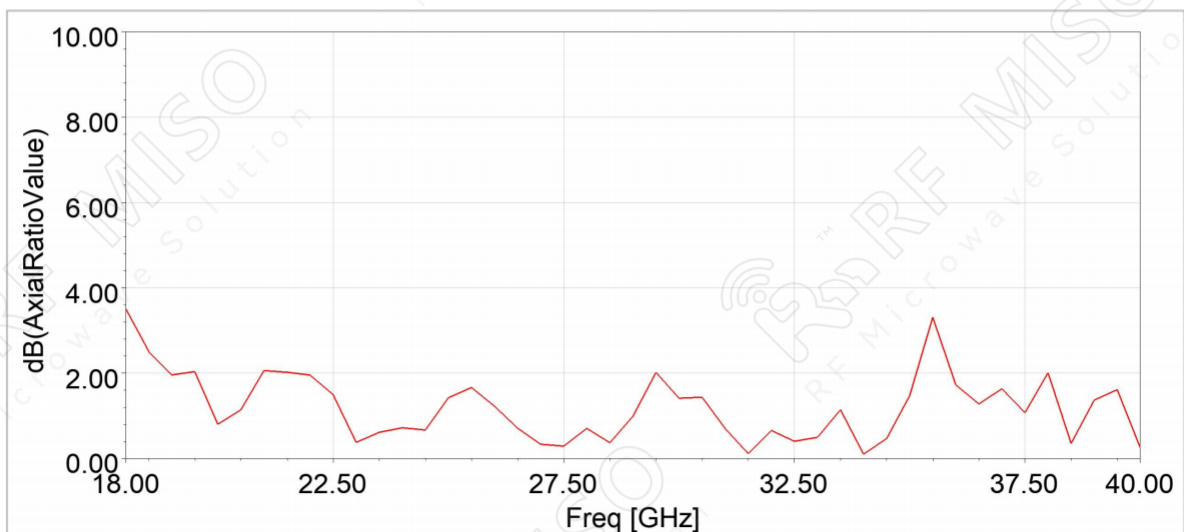

Gain Plot



RM-CPHA1840-12

*Circularly Polarized Horn Antenna 12dBi Typ. Gain,
18-40 GHz Frequency Range*

Circularly Polarized Horn Antenna Data Sheet

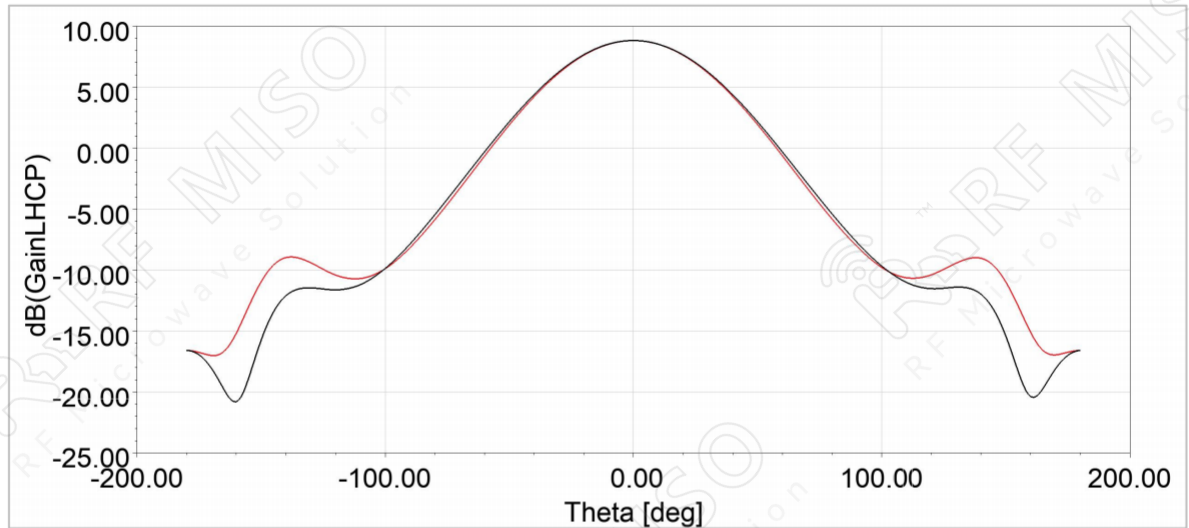

18GHz

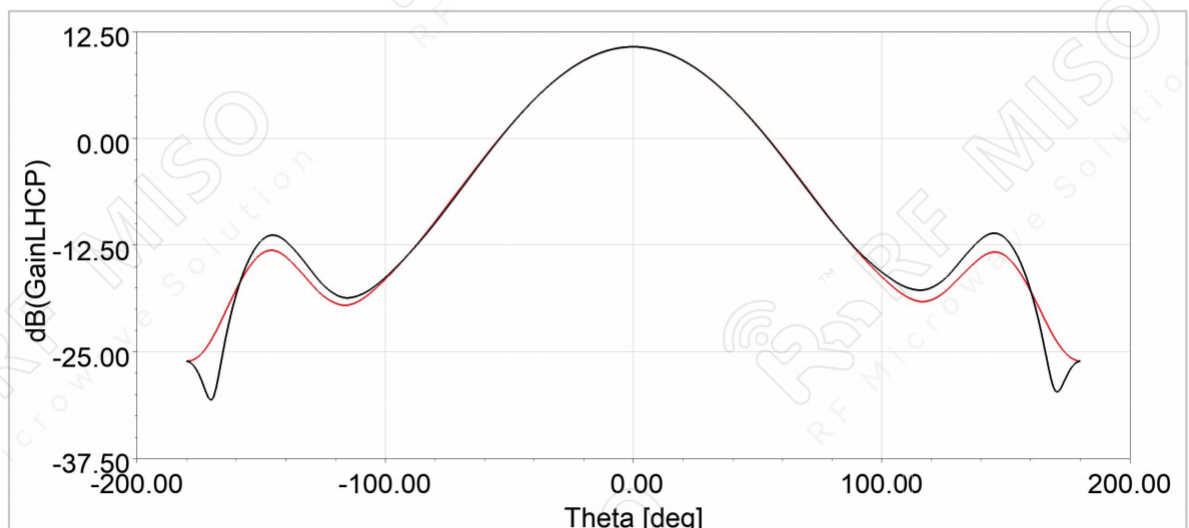

22GHz



RM-CPHA1840-12

*Circularly Polarized Horn Antenna 12dBi Typ. Gain,
18-40 GHz Frequency Range*

Circularly Polarized Horn Antenna Data Sheet

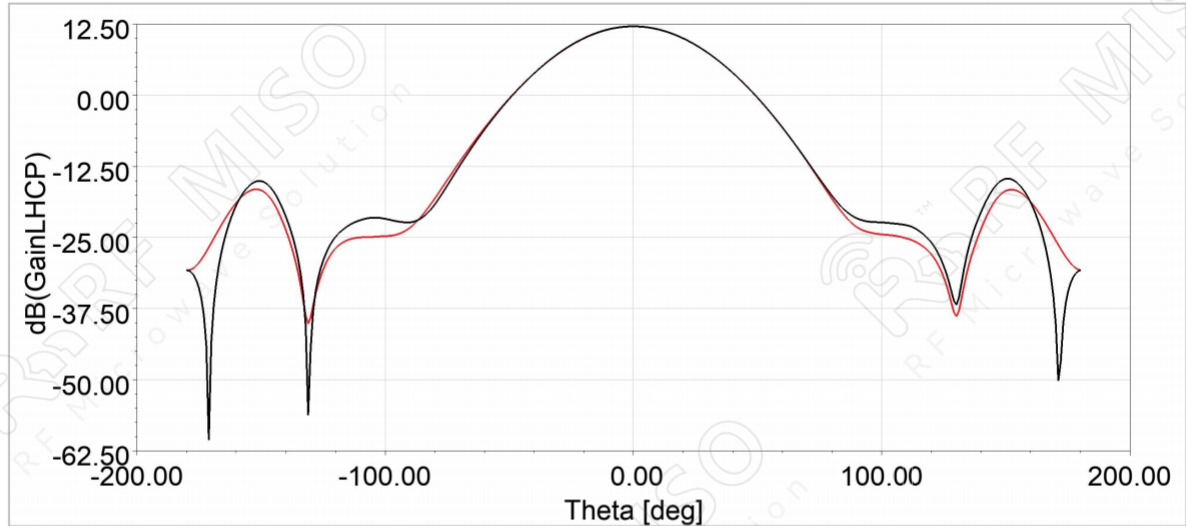

26GHz

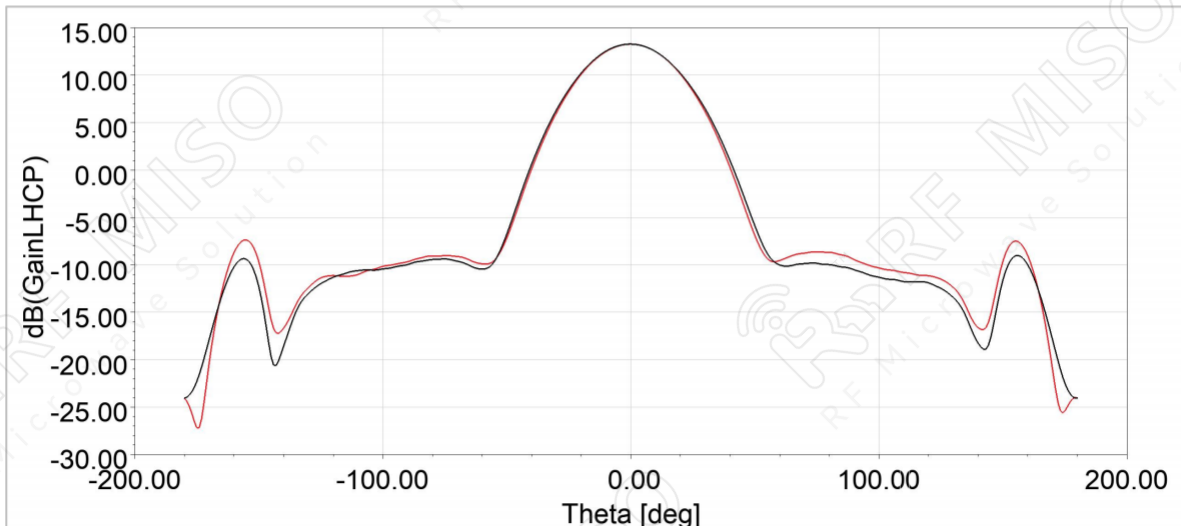

30GHz



RM-CPHA1840-12

*Circularly Polarized Horn Antenna 12dBi Typ. Gain,
18-40 GHz Frequency Range*

Circularly Polarized Horn Antenna Data Sheet

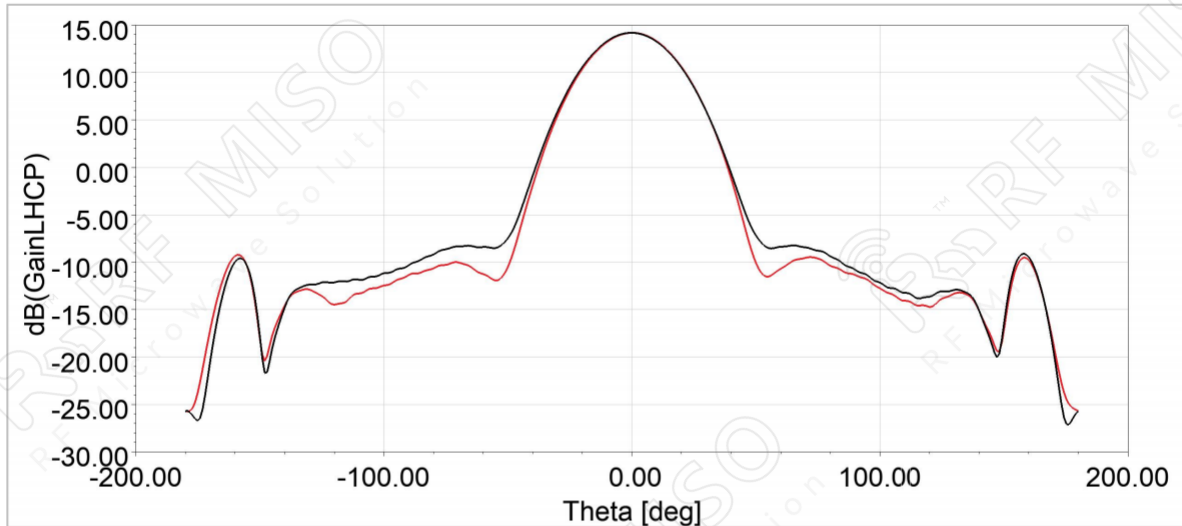

34GHz

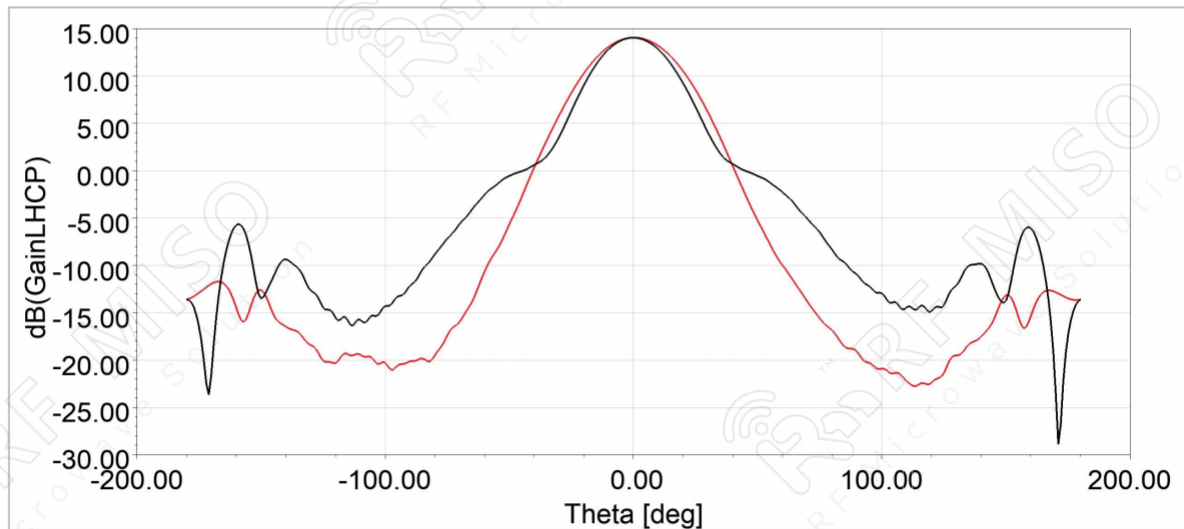

38GHz



*Circularly Polarized Horn Antenna 12dBi Typ. Gain,
18-40 GHz Frequency Range*

Circularly Polarized Horn Antenna Data Sheet

RM-CPHA1840-12

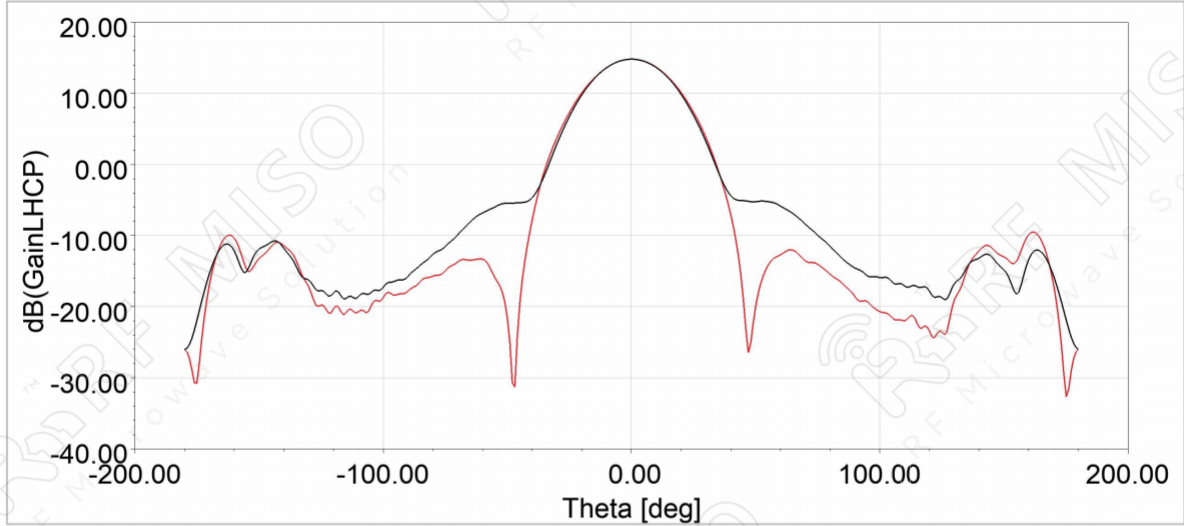

40GHz