



*Circularly Polarized Horn Antenna 16dBi Typ. Gain,
2-18 GHz Frequency Range*

Circularly Polarized Horn Antenna Data Sheet

RM-CPHA218-16

Features

- Low VSWR
- High Power handling
- Symmetrical Plane Beamwidth
- RHCP, LHCP or Dual Circularly Polarized
- Military Airborne Applications

Descriptions

RF MISO's Model RM-CPHA218-16 is RHCP, LHCP or dual circularly polarized horn antenna that operates from 2 to 18GHz. The antenna offers a typical gain of 16 dBi and low VSWR 1.5:1.

The antenna is equipped with an ultra-wideband stripline coupler, suitable for ultra-wideband horn antennas. It has uniform gain in the whole frequency band, providing efficient performance characteristics and directivity. It can be widely used in EMI detection, direction, reconnaissance, antenna gain and pattern measurement and other application fields.

Specifications

RM-CPHA218-16		
Parameters	Specification	Unit
Frequency Range	2-18	GHz
Gain	16 Typ.	dBi
VSWR	1.5 Typ.	
AR	2 Typ.	
Polarization	RHCP or LHCP or Dual Circularly	
Interface	SMA-Female	
Material	Al	
Finishing	Paint	
Average Power	50	W
Peak Power	3000	W
Size (L*W*H)	282*147*153.5 (±5)	mm
Weight	2.53	kg



Circularly Polarized Horn Antenna 16dBi Typ. Gain,
2-18 GHz Frequency Range

Circularly Polarized Horn Antenna Data Sheet

RM-CPHA218-16

Outline Drawing

N type and 2.92mm type connectors are available, please contact RF Miso.

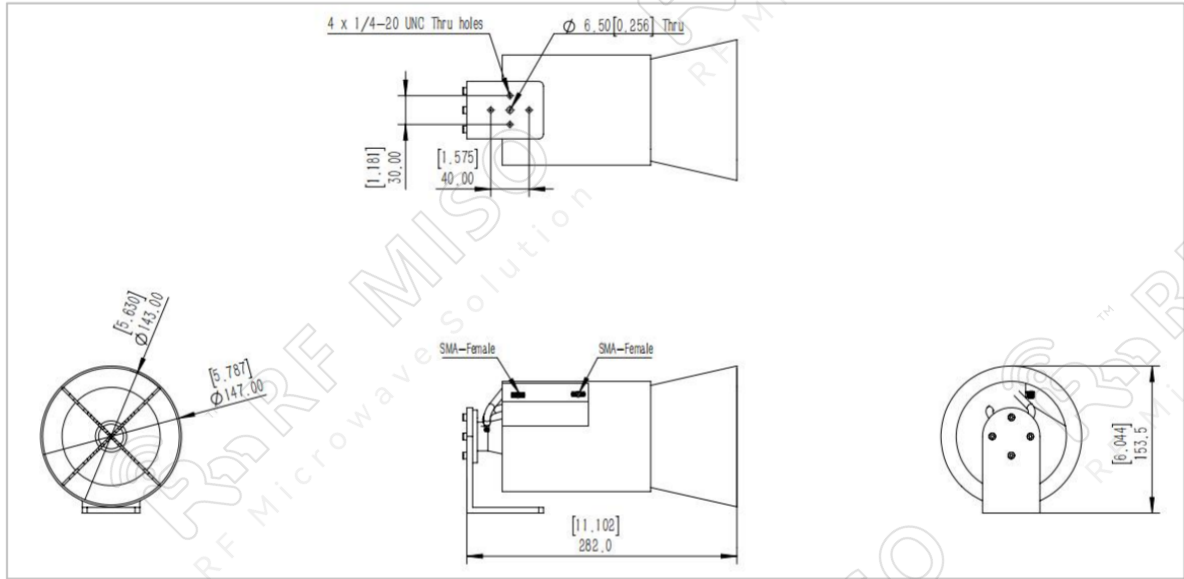

Simulation Data

Gain

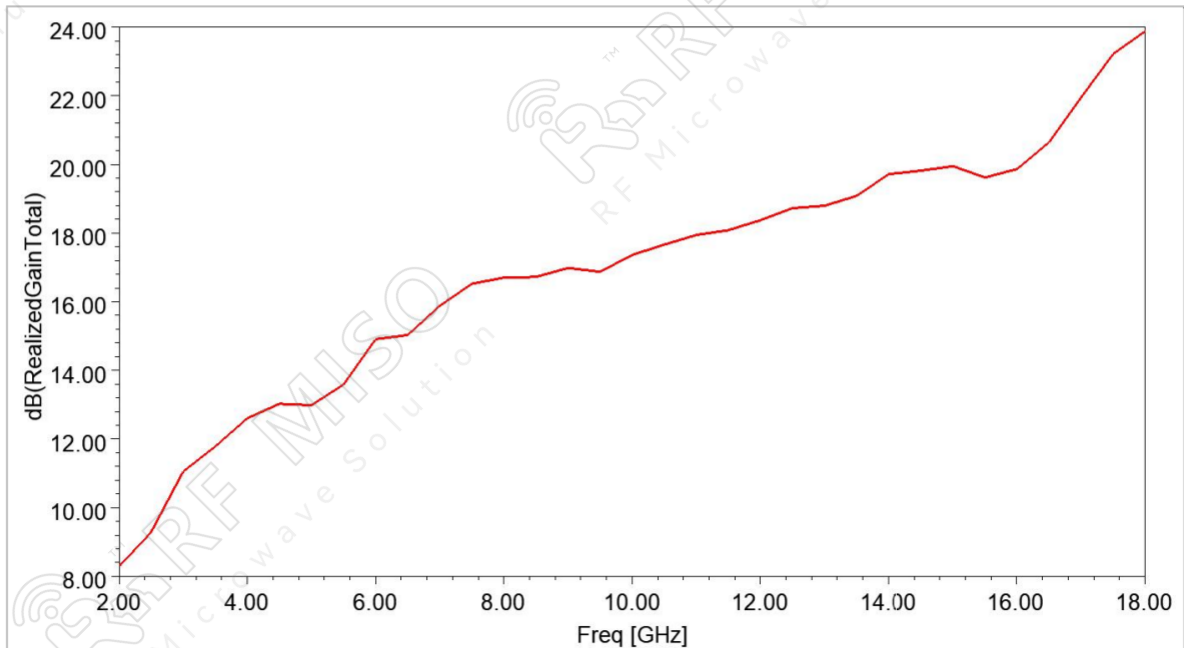



Circularly Polarized Horn Antenna 16dBi Typ. Gain,
2-18 GHz Frequency Range

Circularly Polarized Horn Antenna Data Sheet

RM-CPHA218-16

AR

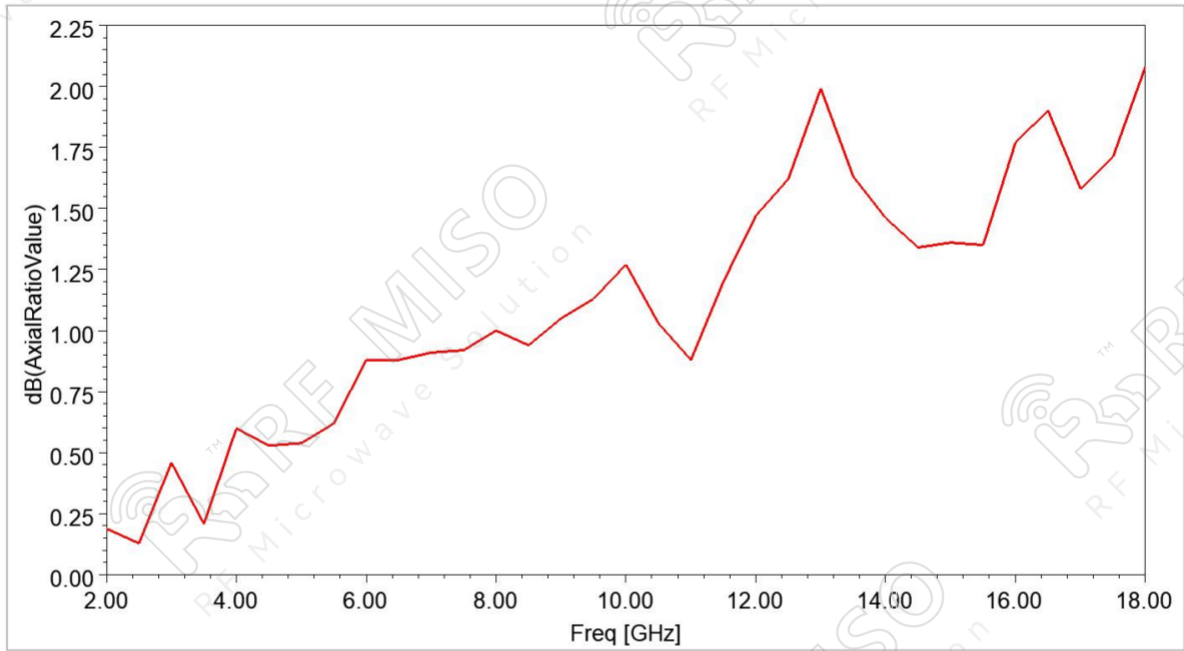

Gain Plot

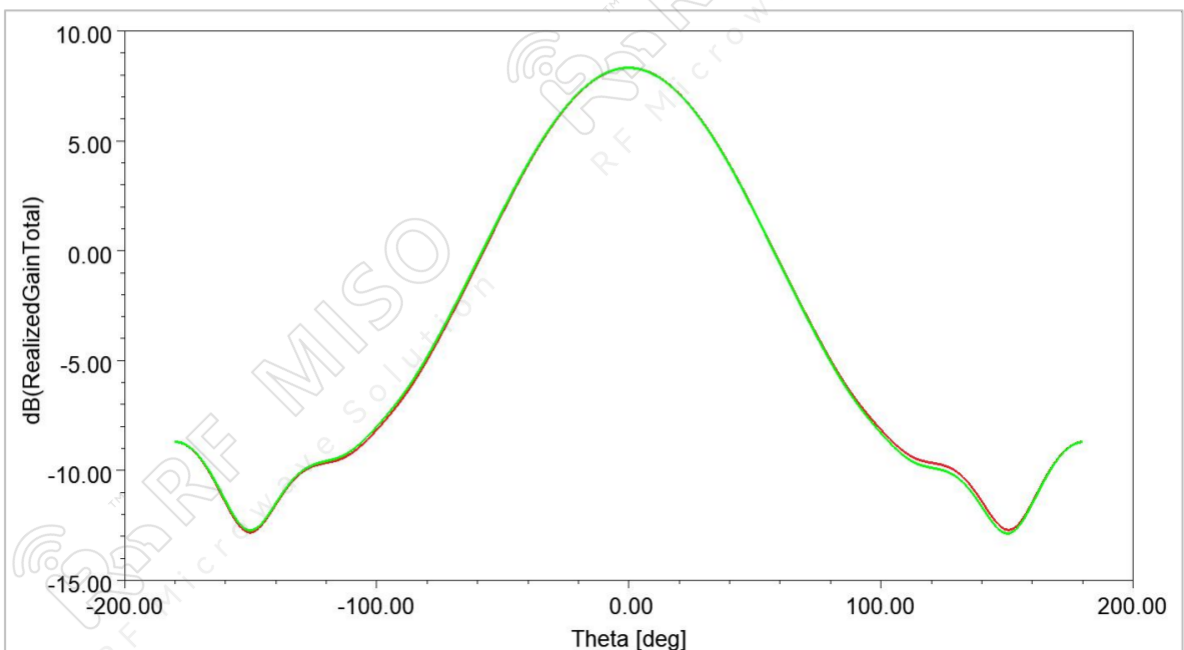

2GHz



Circularly Polarized Horn Antenna 16dBi Typ. Gain,
2-18 GHz Frequency Range

Circularly Polarized Horn Antenna Data Sheet

RM-CPHA218-16

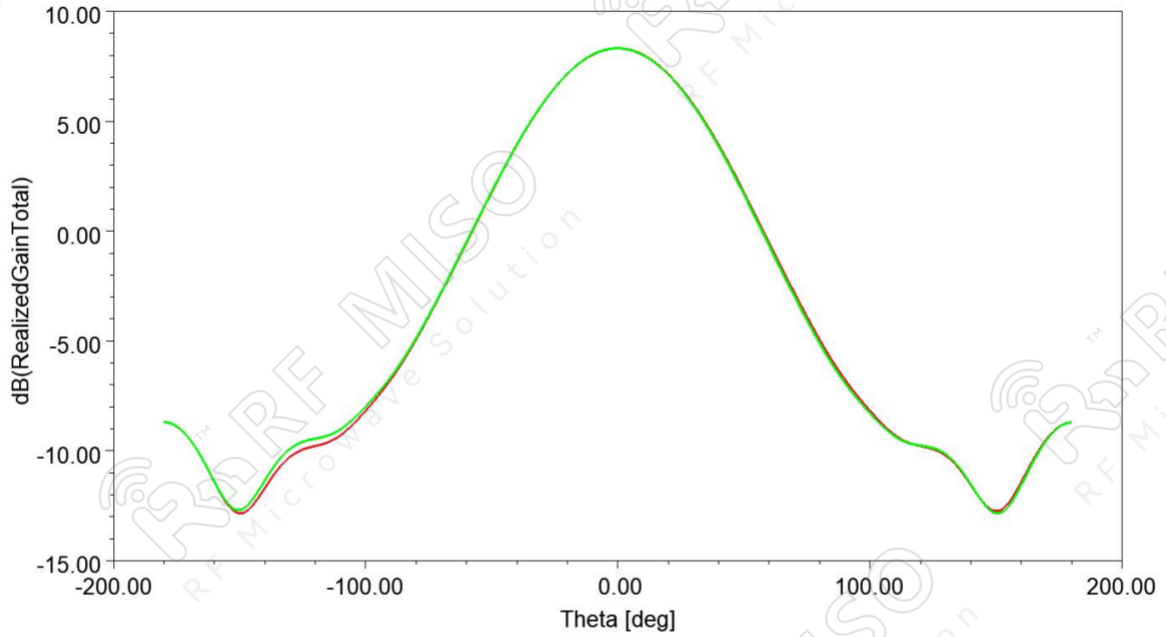

6GHz

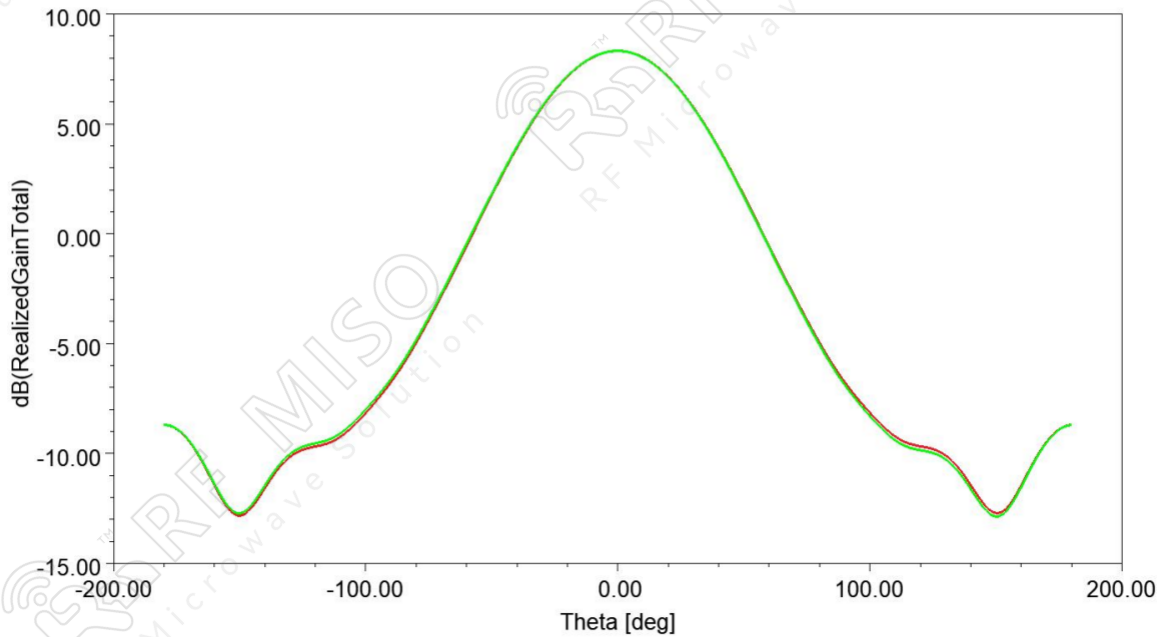

10GHz



Circularly Polarized Horn Antenna 16dBi Typ. Gain,
2-18 GHz Frequency Range

Circularly Polarized Horn Antenna Data Sheet

RM-CPHA218-16

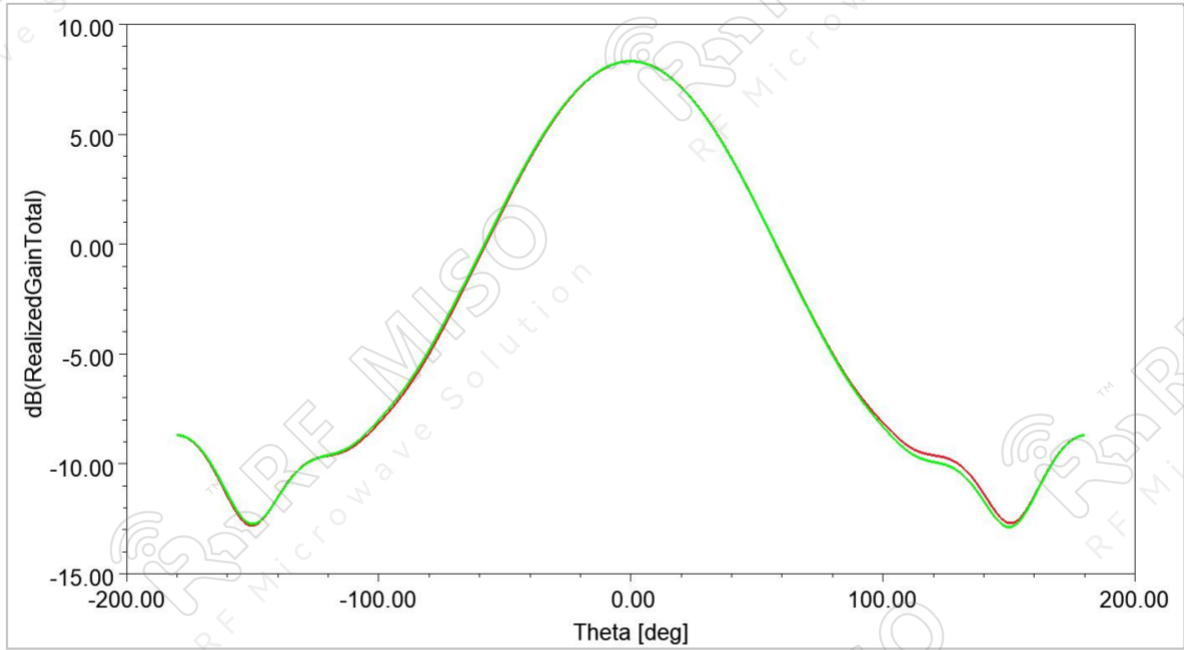

14GHz

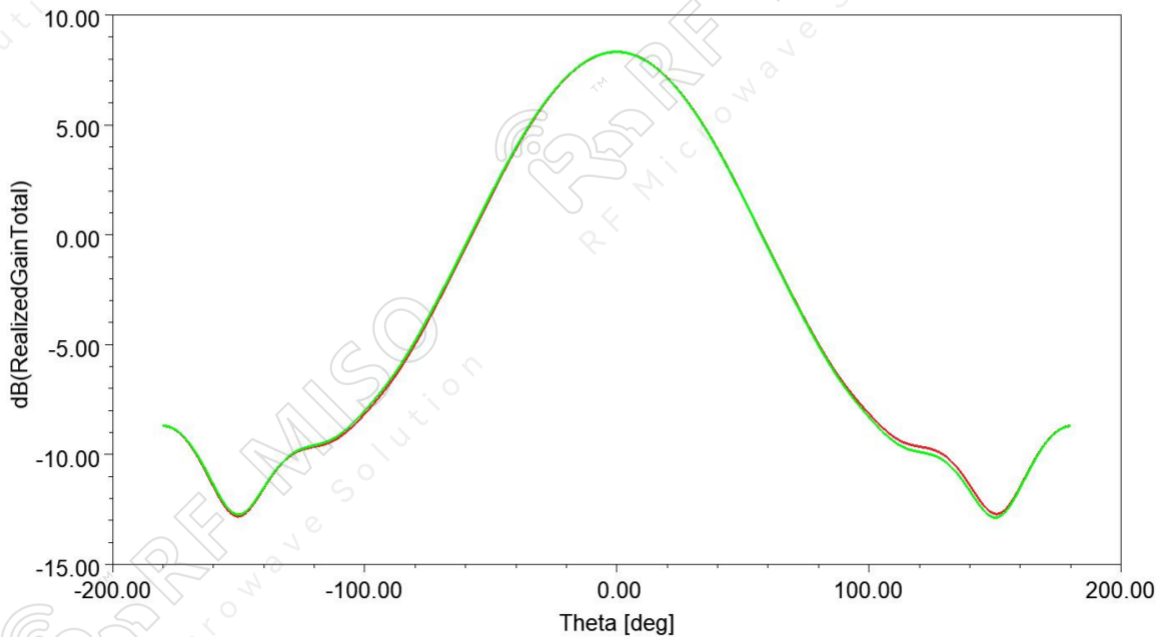

18GHz