

Dual Circular Polarized Horn Antenna
10 dBi Typ. Gain, 2-12GHz Frequency Range

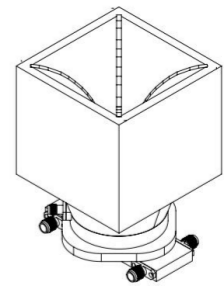

Broadband Horn Antenna Data Sheet

RM-DCPHA212-10

Specifications

RM-DCPHA212-10		
Item	Specification	Units
Frequency Range	2-12	GHz
Gain	10 Typ.	dBi
AR	0.3-2.5	dB
Polarization	Dual Circular Polarized	
Connector	SMA-Female	
Finishing	Paint	
Material	Al	dB
Size(L*W*H)	75*75*108.66(±5)	mm
Weight	231	g

Dual Circular Polarized Horn Antenna
10 dBi Typ. Gain, 2-12GHz Frequency Range

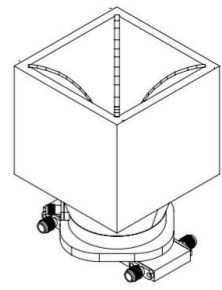

Broadband Horn Antenna Data Sheet

RM-DCPHA212-10

Outline Drawing

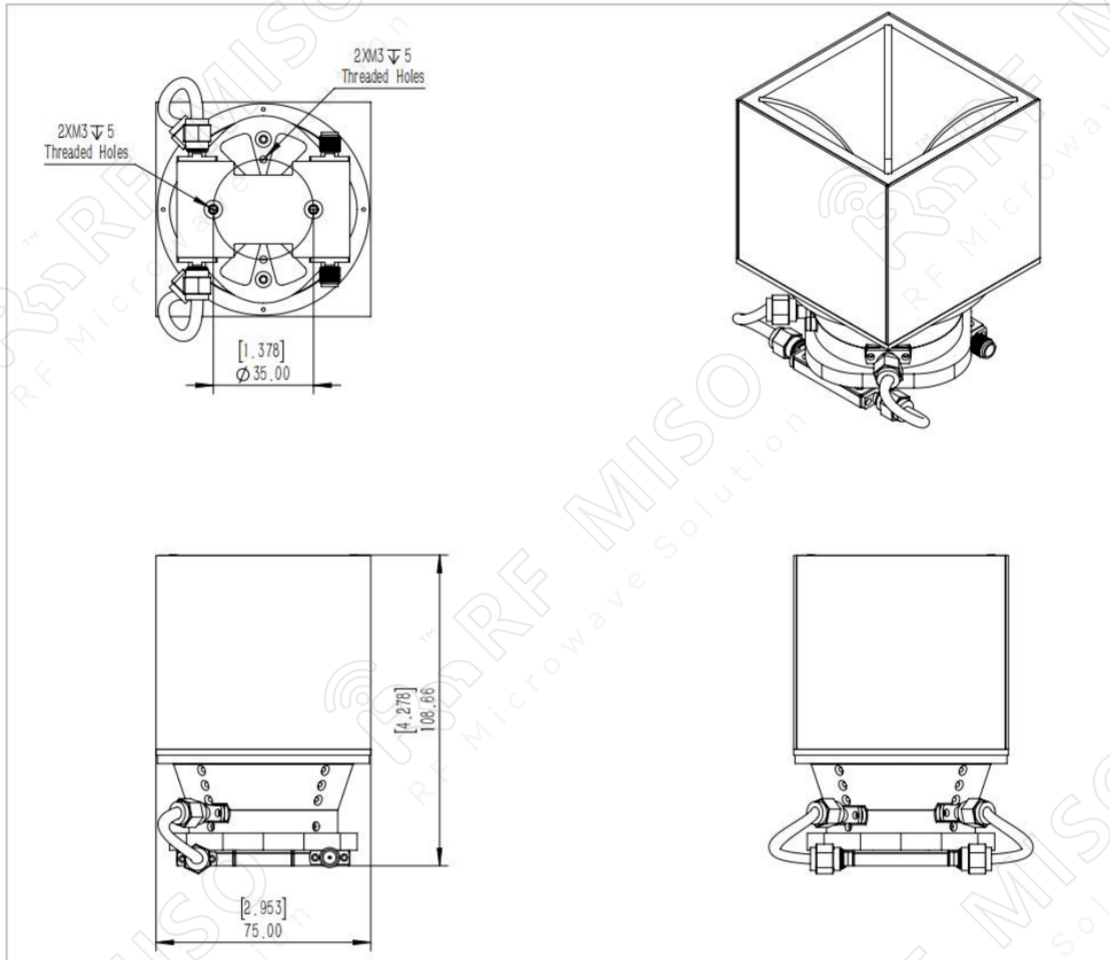

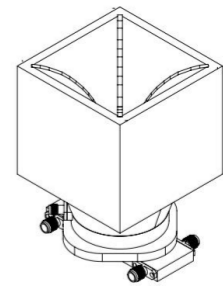

Dual Circular Polarized Horn Antenna
10 dBi Typ. Gain, 2-12GHz Frequency Range

Broadband Horn Antenna Data Sheet

RM-DCPHA212-10

Simulation Data

VSWR

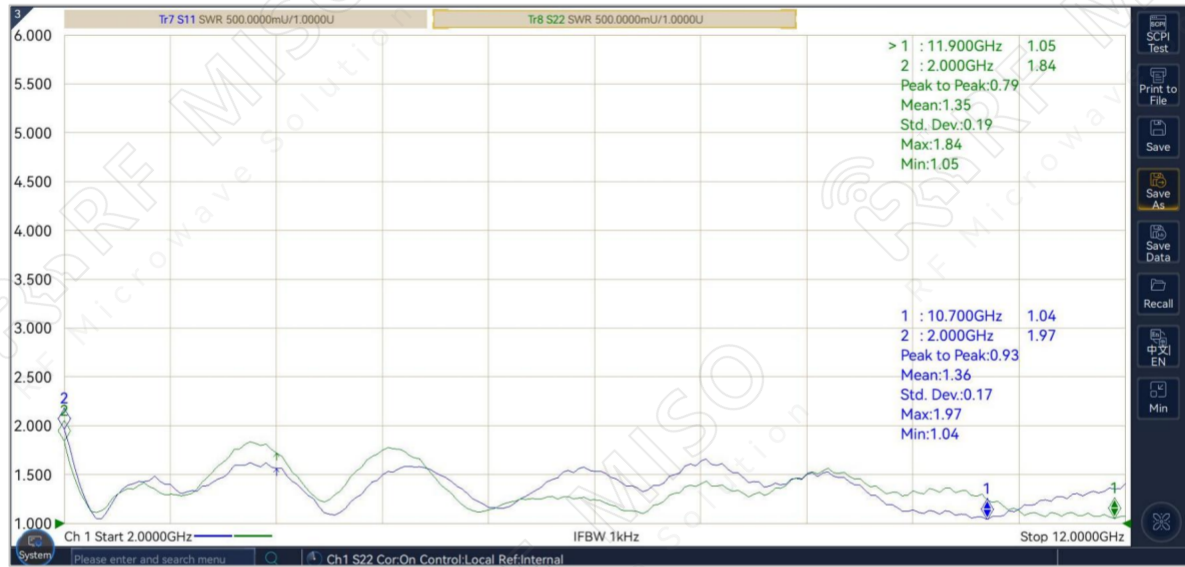

Gain@2-12GHz

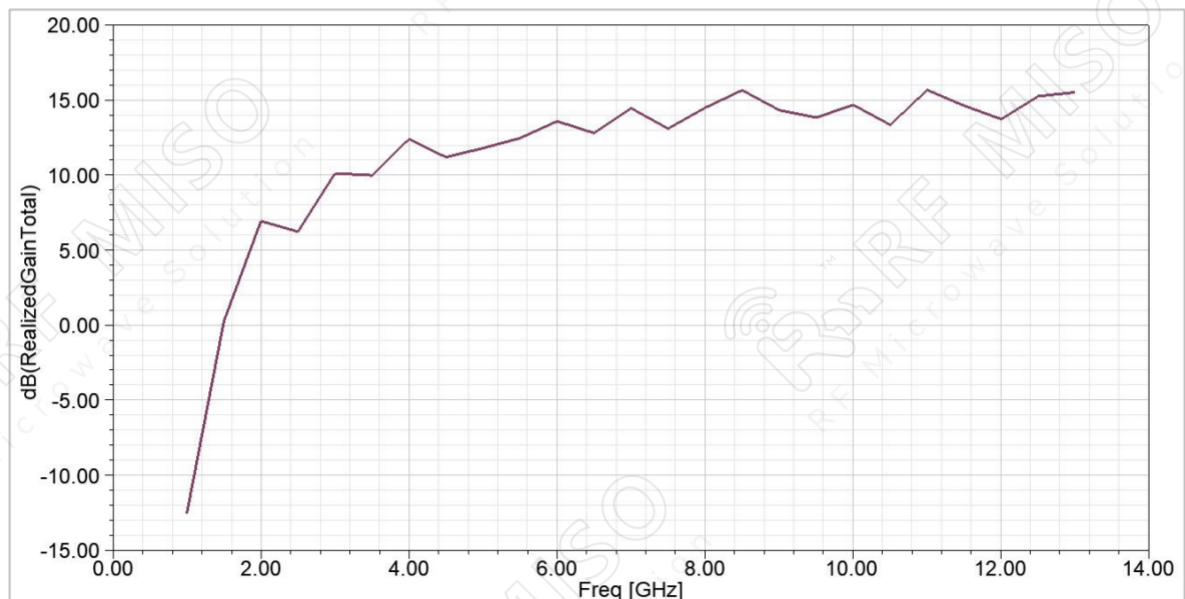

Dual Circular Polarized Horn Antenna
10 dBi Typ. Gain, 2-12GHz Frequency Range

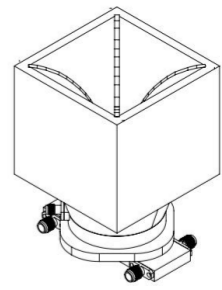

Broadband Horn Antenna Data Sheet

RM-DCPHA212-10

AR@2-12GHz

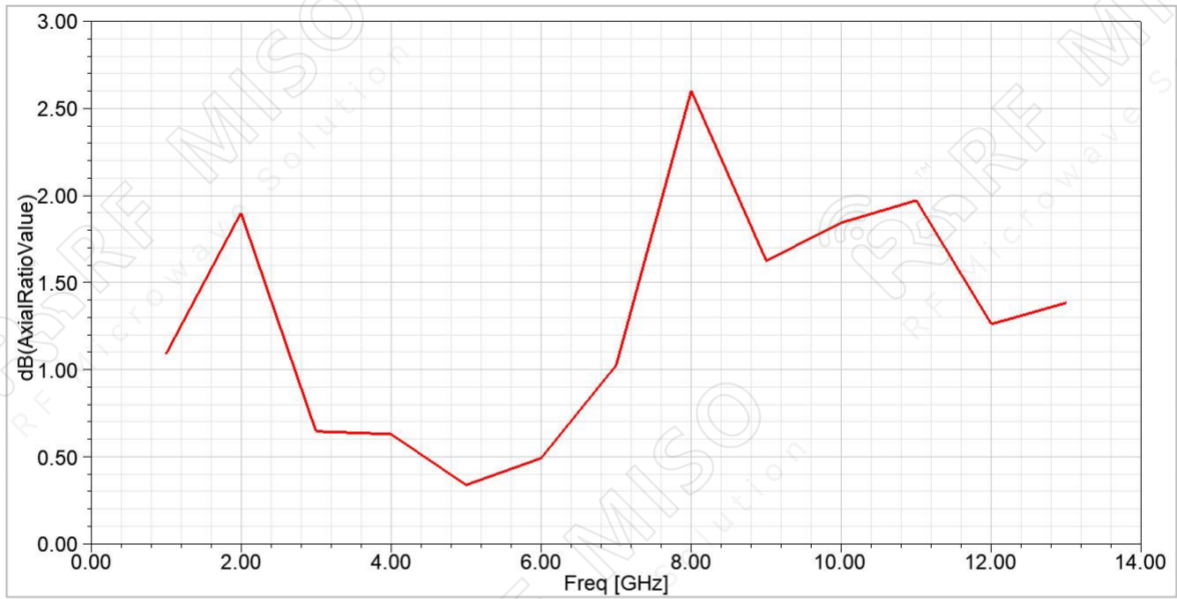

Cross Polarization@2-12GHz

