



*Dual Polarized Horn Antenna
16dBi Typ.Gain, 60GHz-90GHz Frequency Range*

Dual Polarized Horn Antenna Data Sheet

RM-DPHA6090-16

Features

- Full E Band Performance
- Dual Polarization
- High Port Isolation
- Precisely Machined and Gold Plated

Description

The **RM-DPHA6090-16** is a full-band, dual-polarized, WR-12 horn antenna assembly that operates in the frequency range of 60 to 90GHz. The antenna features an integrated orthogonal mode converter that provides high port isolation. The RM-DPHA6090-16 supports vertical and horizontal waveguide orientations and has a typical 35 dB cross-polarization isolation, a nominal gain of 16 dBi at the center frequency, a typical 3db beamwidth of 28 degrees in the E-plane, a typical 3db beamwidth of 33 degrees in the H-plane. The input to the antenna is a WR-12 waveguide with a UG-387/U-M threaded flange.

Specifications

RM-DPHA6090-16		
Item	Specification	Units
Frequency Range	60-90	GHz
Gain	16 Typ.	dBi
VSWR	1.3:1 Typ.	
Polarization	Dual	
3dB Beam Width E Plane	28 Typ.	Degrees
3dB Bean Width H Plane	33 Typ.	Degrees
Port Isolation	45 Typ.	dB
Waveguide Size	WR-12	
Flange Designation	UG-387/U	
Size	51.7*20*20	mm
Weight	0.074	Kg
Body Material and Finish	Cu, Gold	



Dual Polarized Horn Antenna
16dBi Typ.Gain, 60GHz-90GHz Frequency Range

Dual Polarized Horn Antenna Data Sheet

RM-DPHA6090-16

Outline Drawing

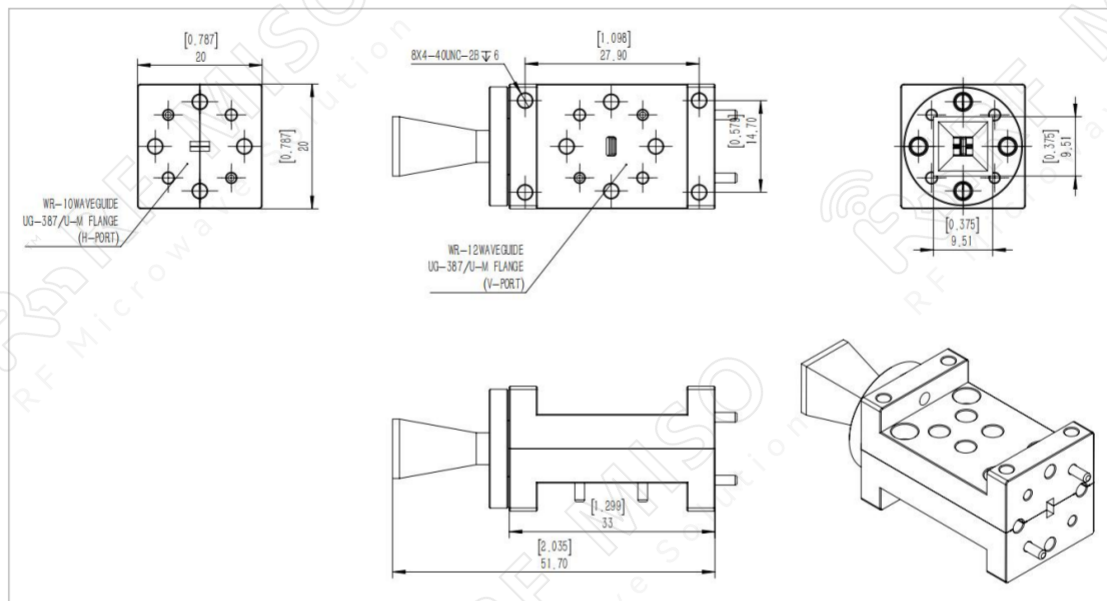

Simulated Data

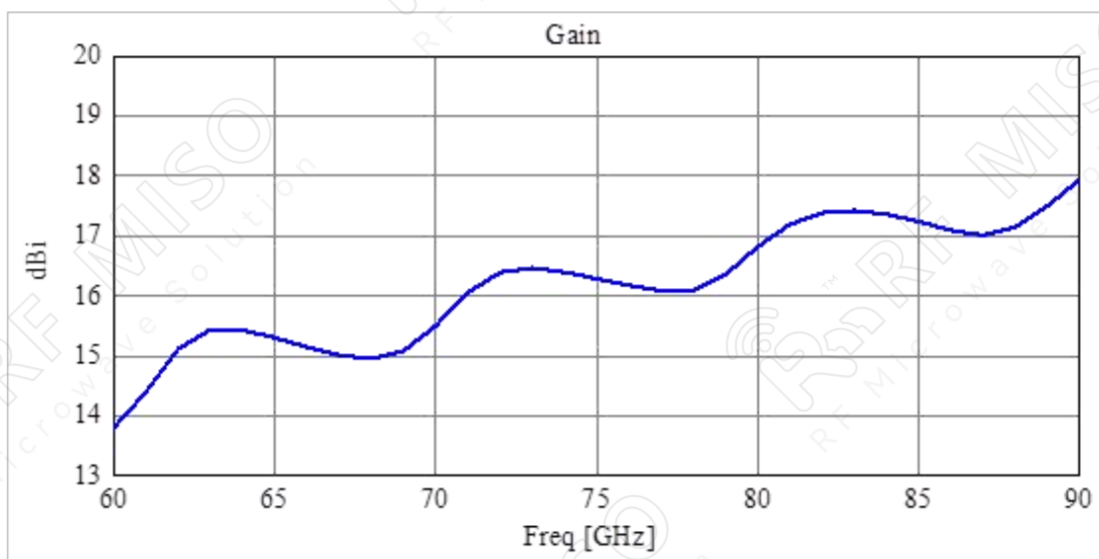



Dual Polarized Horn Antenna
16dBi Typ.Gain, 60GHz-90GHz Frequency Range

Dual Polarized Horn Antenna Data Sheet

RM-DPHA6090-16

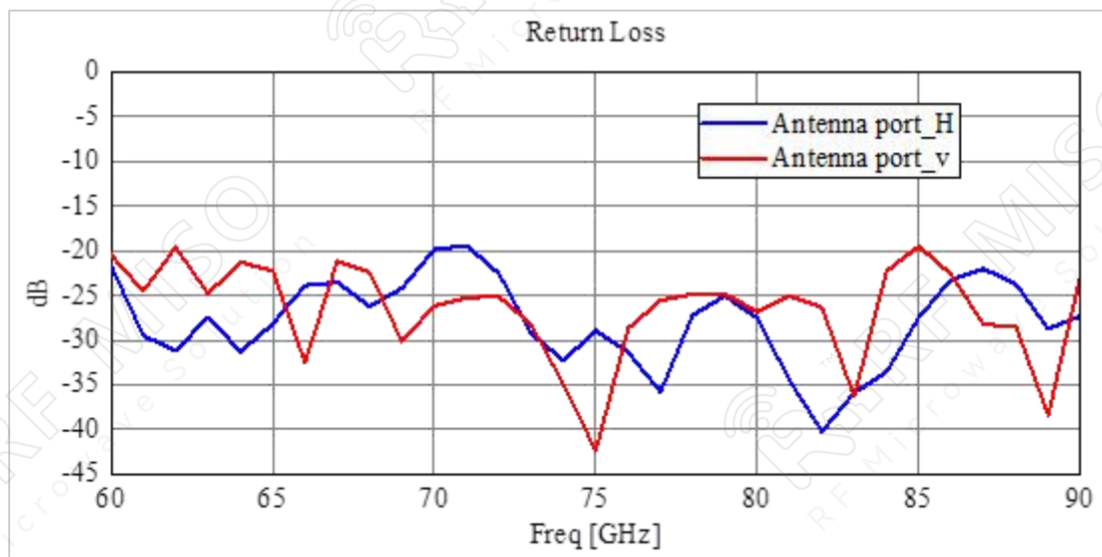
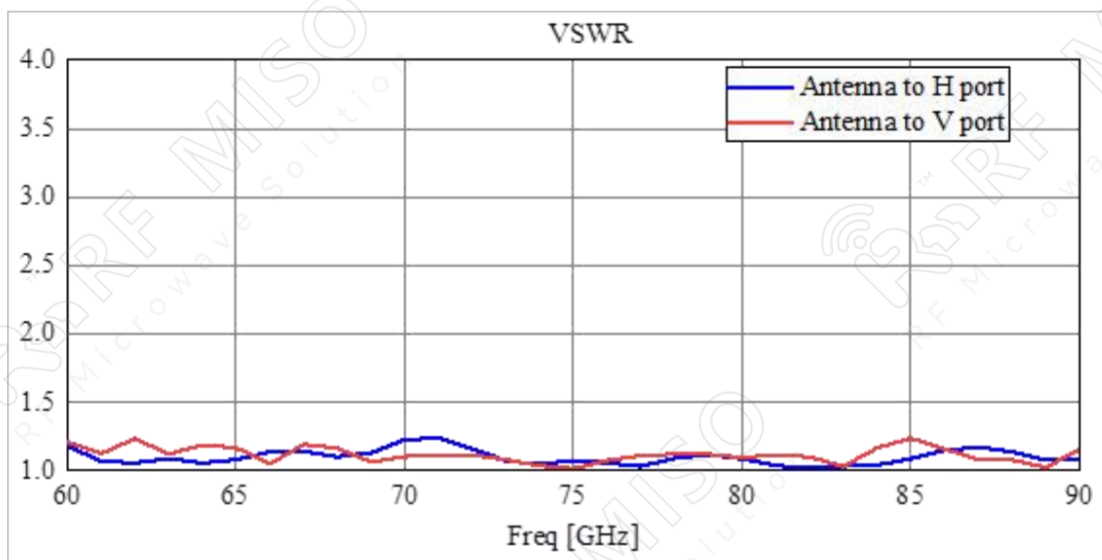



Dual Polarized Horn Antenna
16dBi Typ.Gain, 60GHz-90GHz Frequency Range

Dual Polarized Horn Antenna Data Sheet

RM-DPHA6090-16

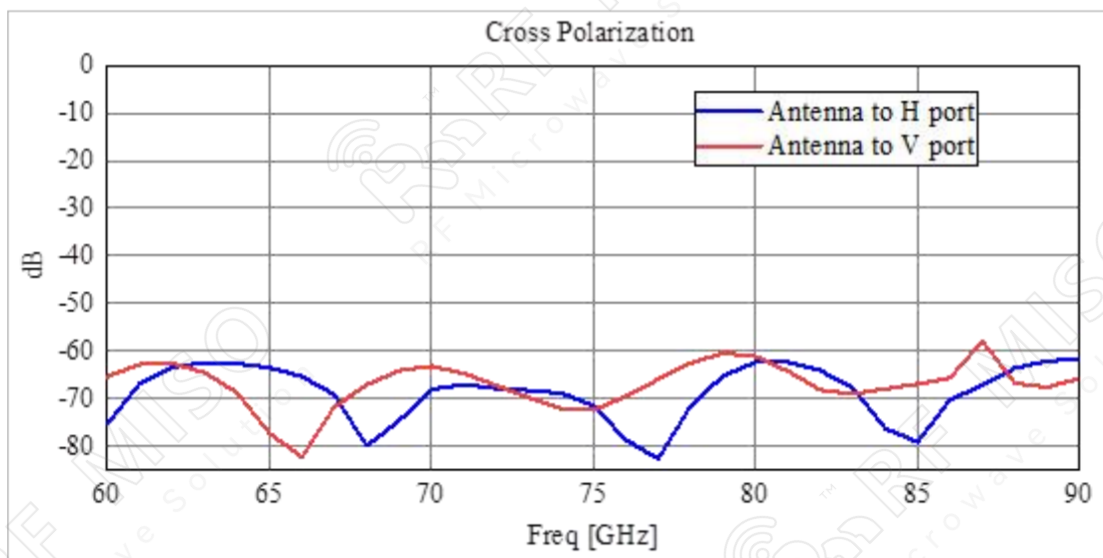
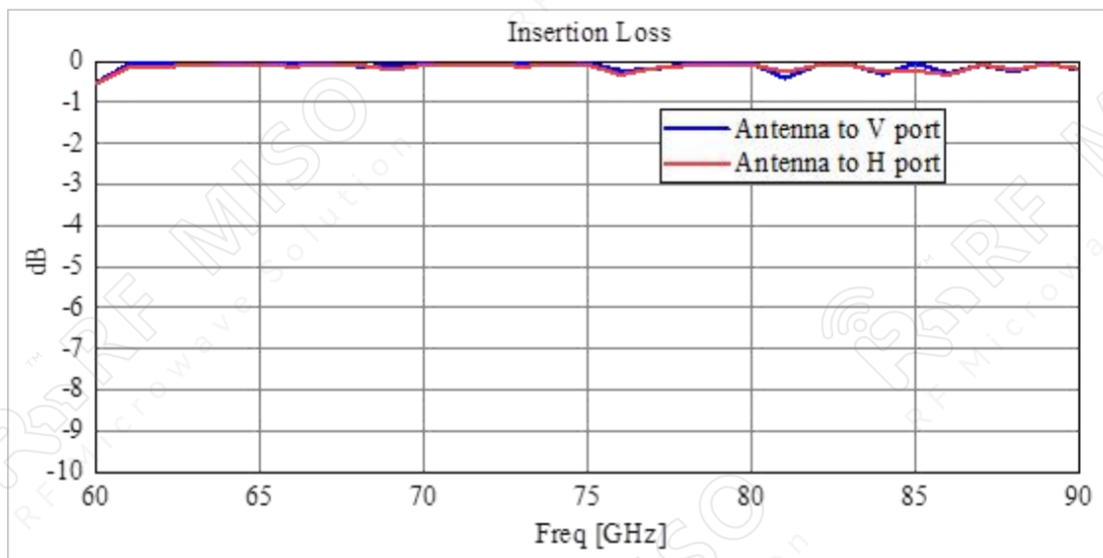



Dual Polarized Horn Antenna
16dBi Typ.Gain, 60GHz-90GHz Frequency Range

Dual Polarized Horn Antenna Data Sheet

RM-DPHA6090-16

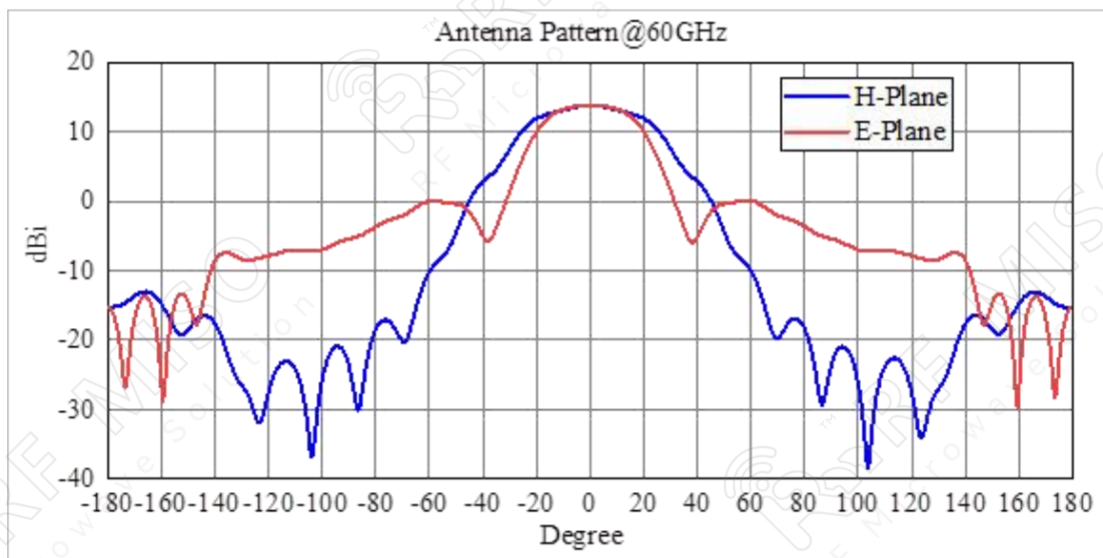
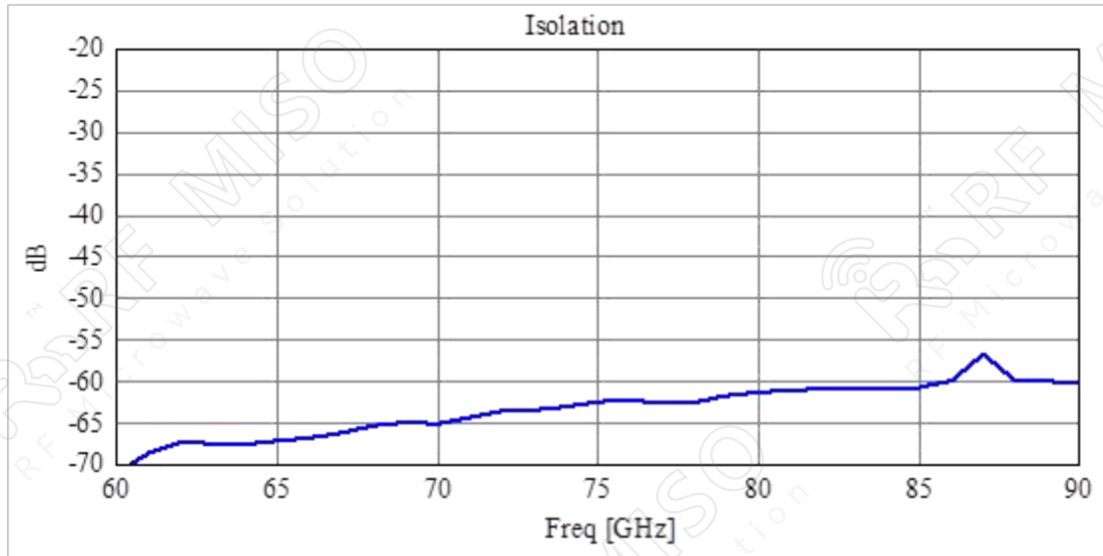



Dual Polarized Horn Antenna
16dBi Typ.Gain, 60GHz-90GHz Frequency Range

Dual Polarized Horn Antenna Data Sheet

RM-DPHA6090-16

