

Standard Gain Horn Antenna  
15dBi Typ. Gain, 1-1.8 GHz Frequency Range

## Standard Gain Horn Antenna Data Sheet

**RM-SGHA650-15**

### Features

- Wave-guide and Connector Interface
- Low Side-lobe
- Linear Polarization
- High Return Loss

### Descriptions

RF MISO's **Model RM-SGHA650-15** is a linear polarized standard gain horn antenna that operates from 1 to 1.8 GHz. The antenna offers a typical gain of 15 dBi and low VSWR 1.2:1. This antenna has flange input and coaxial input for customers to rotate.

### Specifications

Parameters	Specification	Unit
Frequency Range	1-1.8	GHz
Wave-guide	WR650	
Gain	15 Typ.	dBi
VSWR	1.2 Typ.	
Polarization	Linear	
3 dB Beamwidth, E-Plane	33.41° Typ.	
3 dB Beamwidth, H-Plane	31.03° Typ.	
Interface(C Type)	N-Female	
Material	Al	
Finishing	Paint	
Size, C Type (L*W*H)	1071*468.35*327.54 (±5)	mm
Weight	8.922	kg

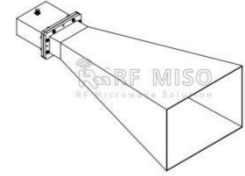

Standard Gain Horn Antenna  
15dBi Typ. Gain, 1-1.8 GHz Frequency Range

**Standard Gain Horn Antenna Data Sheet**

**RM-SGHA650-15**

**C Type Outline Drawing**

SMA-F connector is available, please contact RF Miso

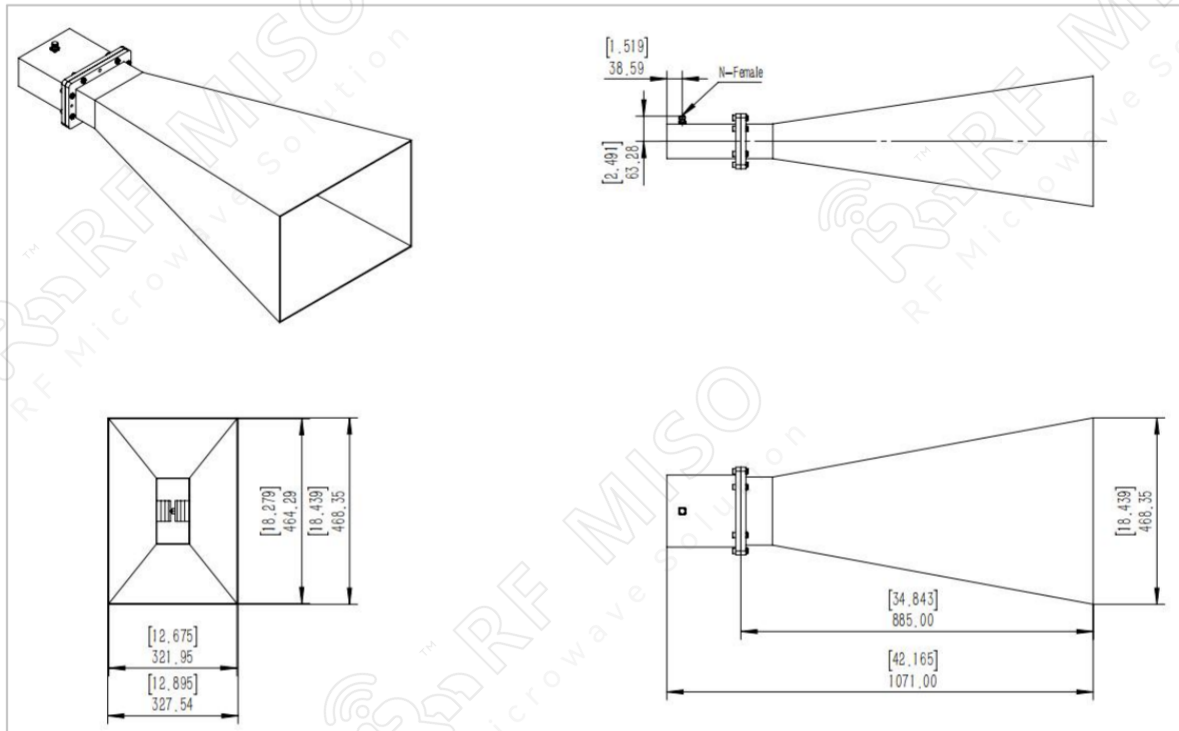

**VSWR**

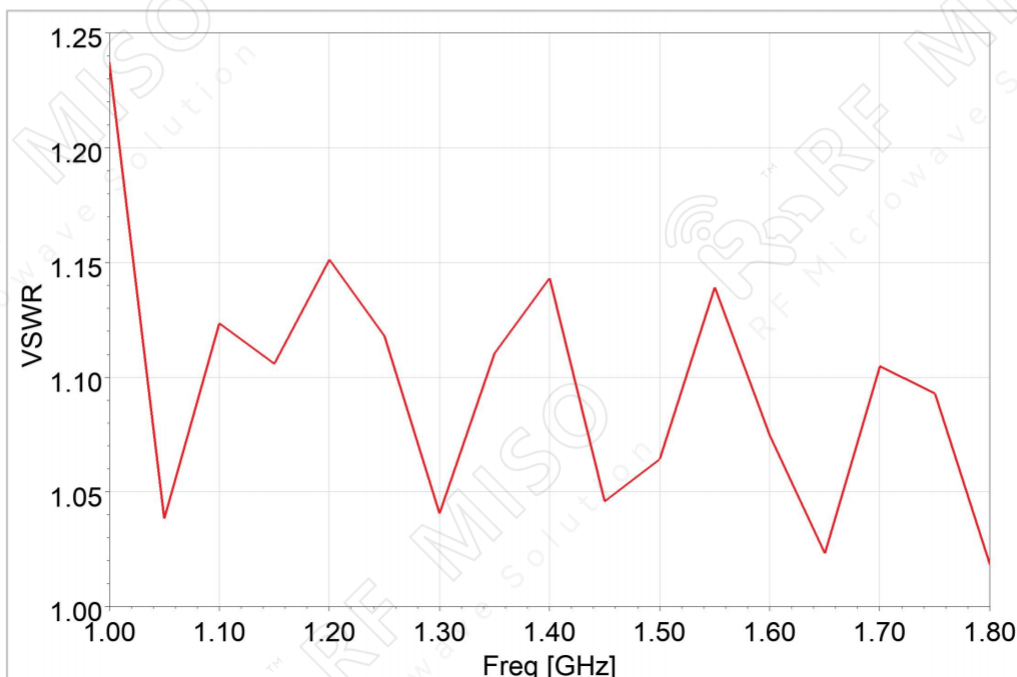

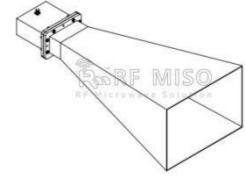

Standard Gain Horn Antenna  
15dBi Typ. Gain, 1-1.8 GHz Frequency Range

**Standard Gain Horn Antenna Data Sheet**

**RM-SGHA650-15**

Gain

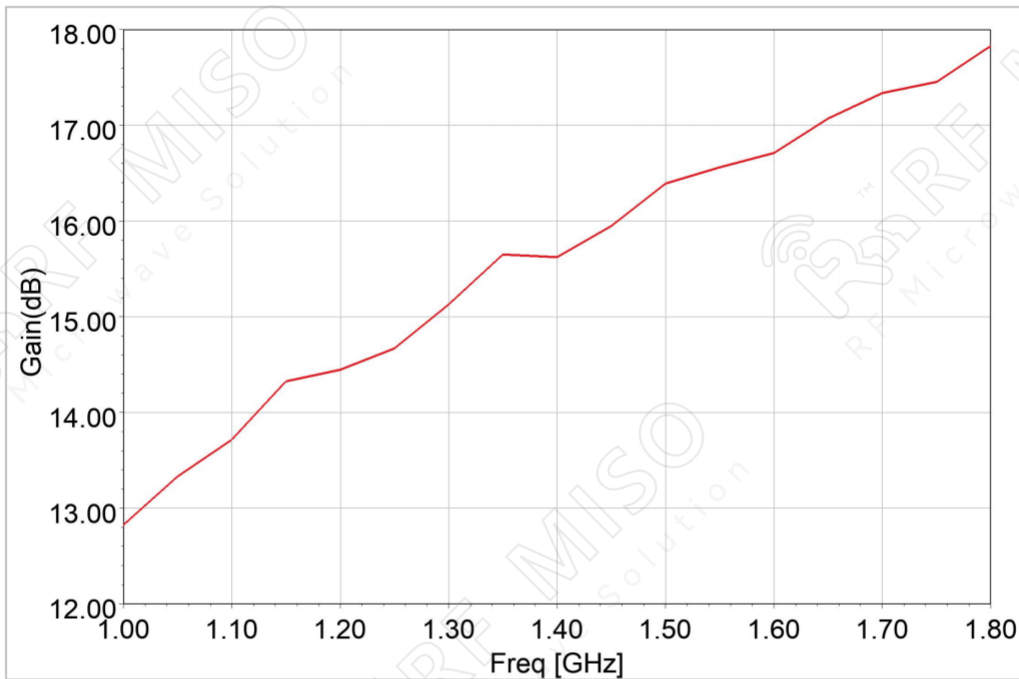

XPD

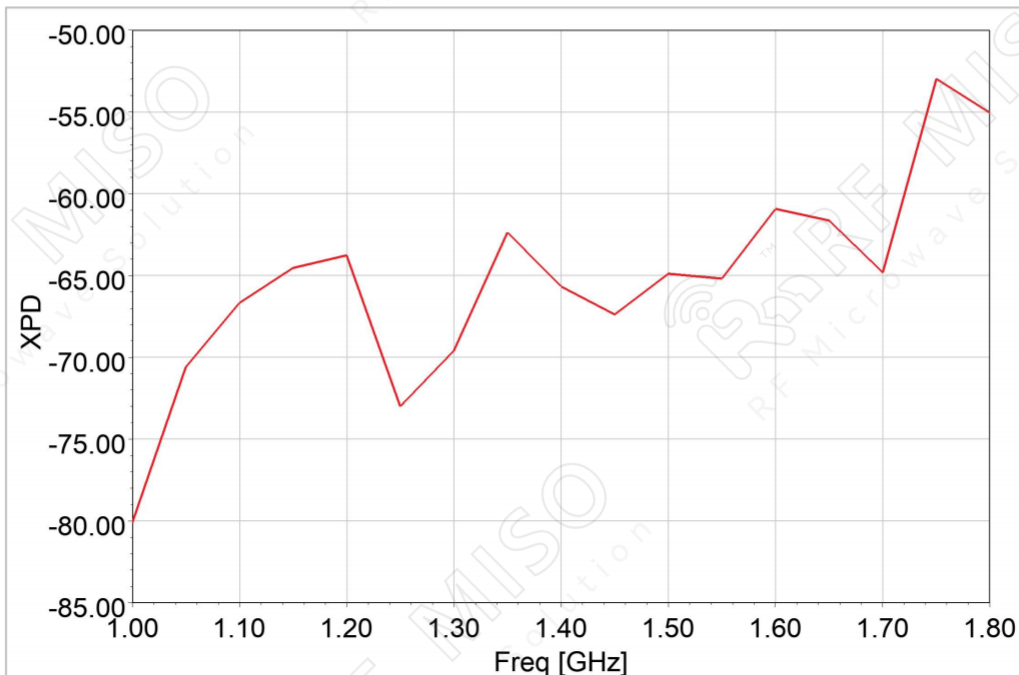

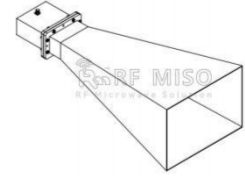

Standard Gain Horn Antenna  
15dBi Typ. Gain, 1-1.8 GHz Frequency Range

**Standard Gain Horn Antenna Data Sheet**

**RM-SGHA650-15**

**Gain Pattern**

1 GHz

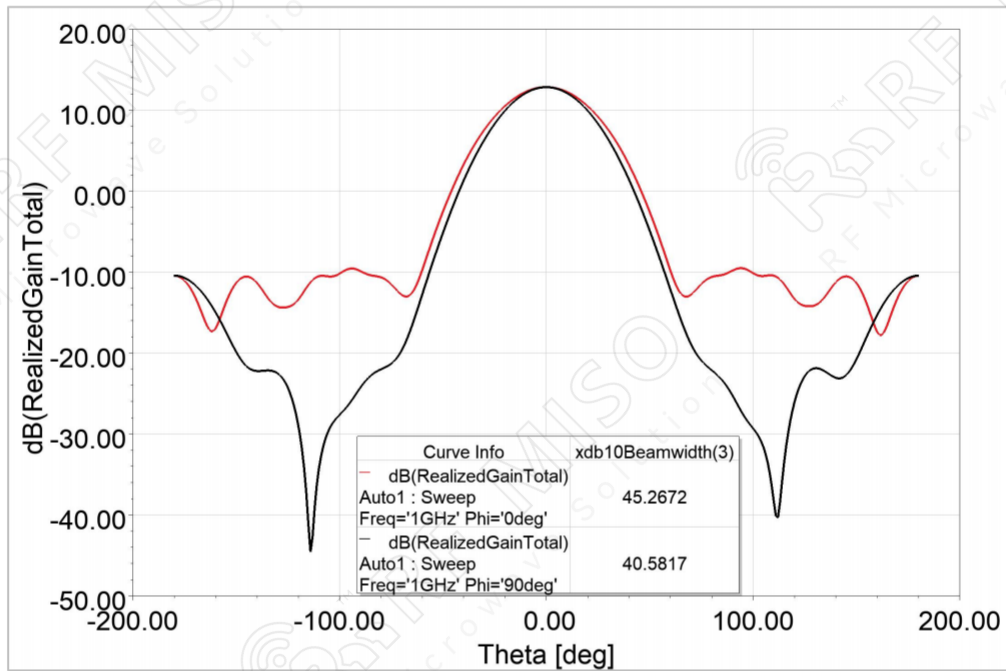

1.1 GHz

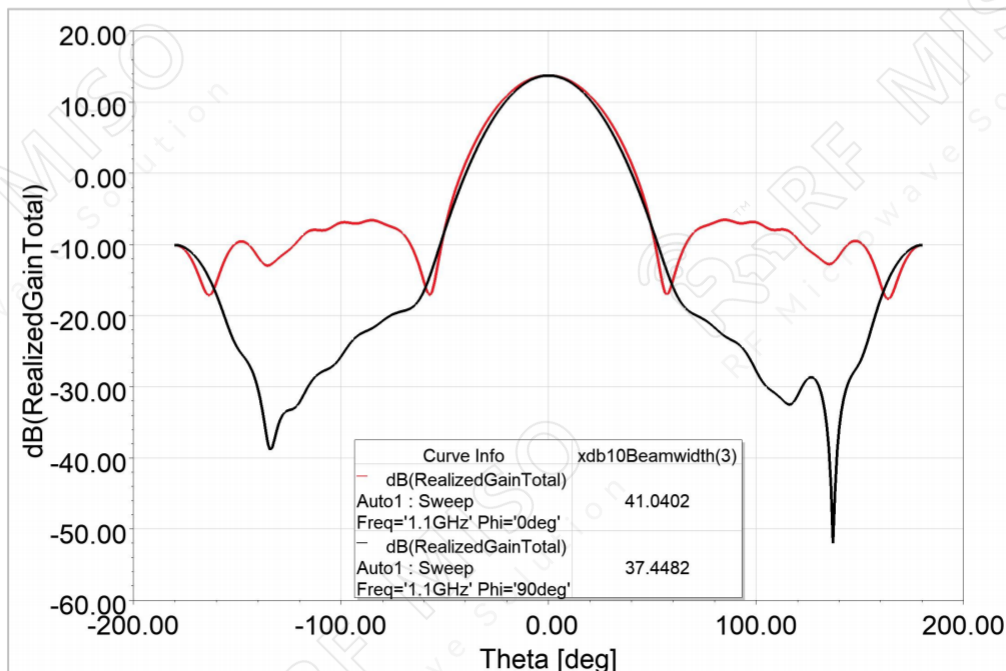

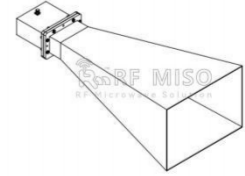

Standard Gain Horn Antenna  
15dBi Typ. Gain, 1-1.8 GHz Frequency Range

**Standard Gain Horn Antenna Data Sheet**

**RM-SGHA650-15**

1.2 GHz

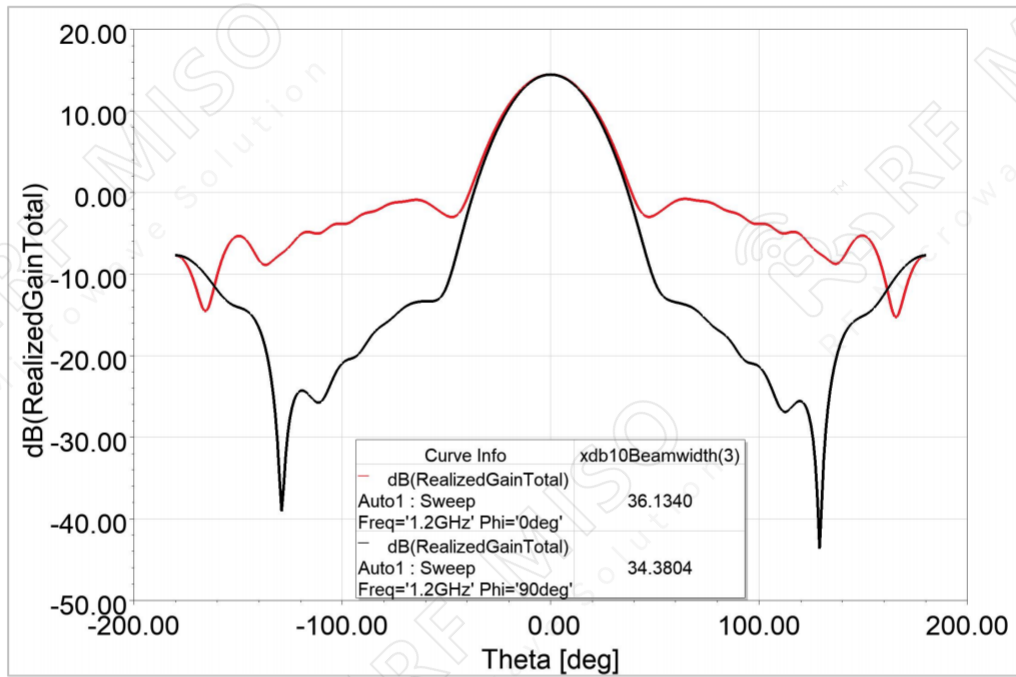

1.3 GHz

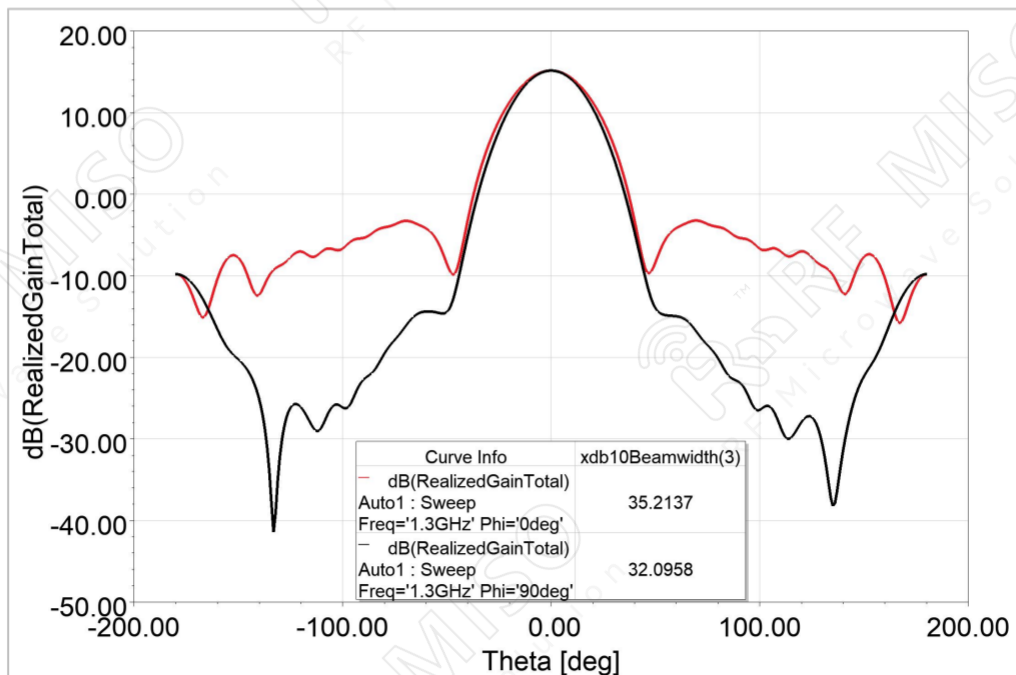

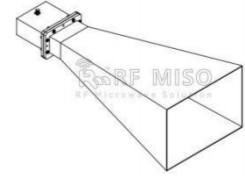

Standard Gain Horn Antenna  
15dBi Typ. Gain, 1-1.8 GHz Frequency Range

**Standard Gain Horn Antenna Data Sheet**

**RM-SGHA650-15**

1.4 GHz

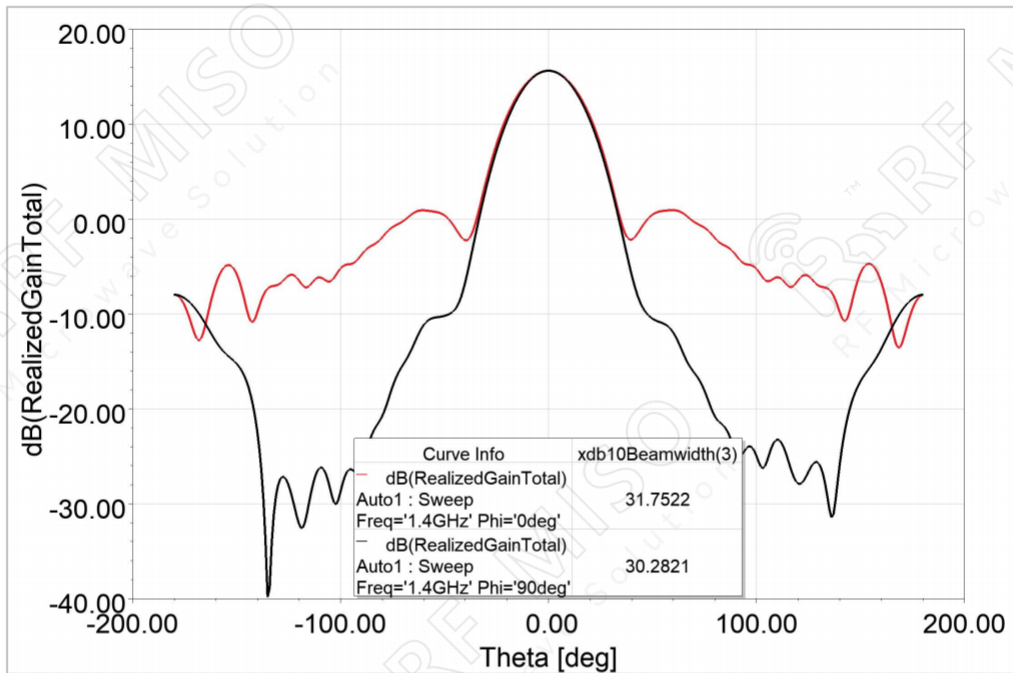

1.5 GHz

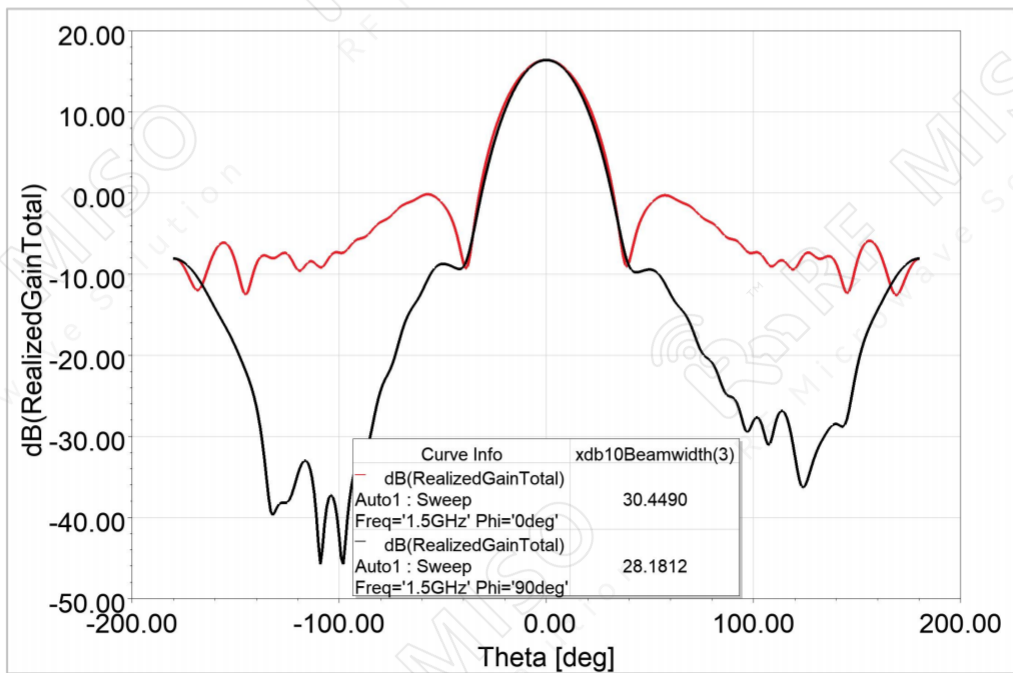

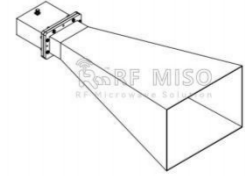

Standard Gain Horn Antenna  
15dBi Typ. Gain, 1-1.8 GHz Frequency Range

**Standard Gain Horn Antenna Data Sheet**

**RM-SGHA650-15**

1.6 GHz

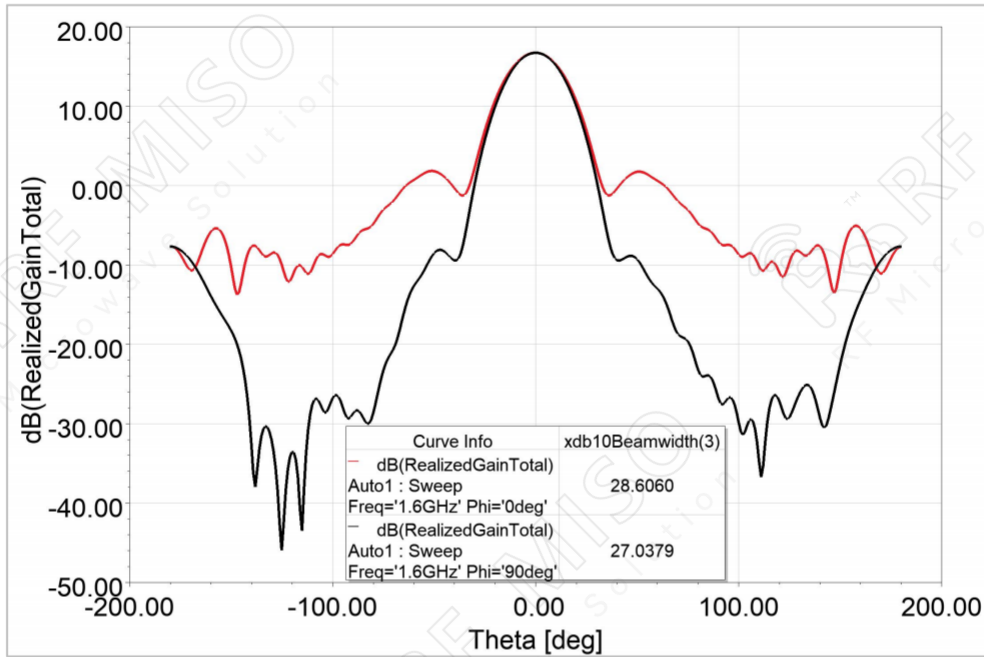

1.7 GHz

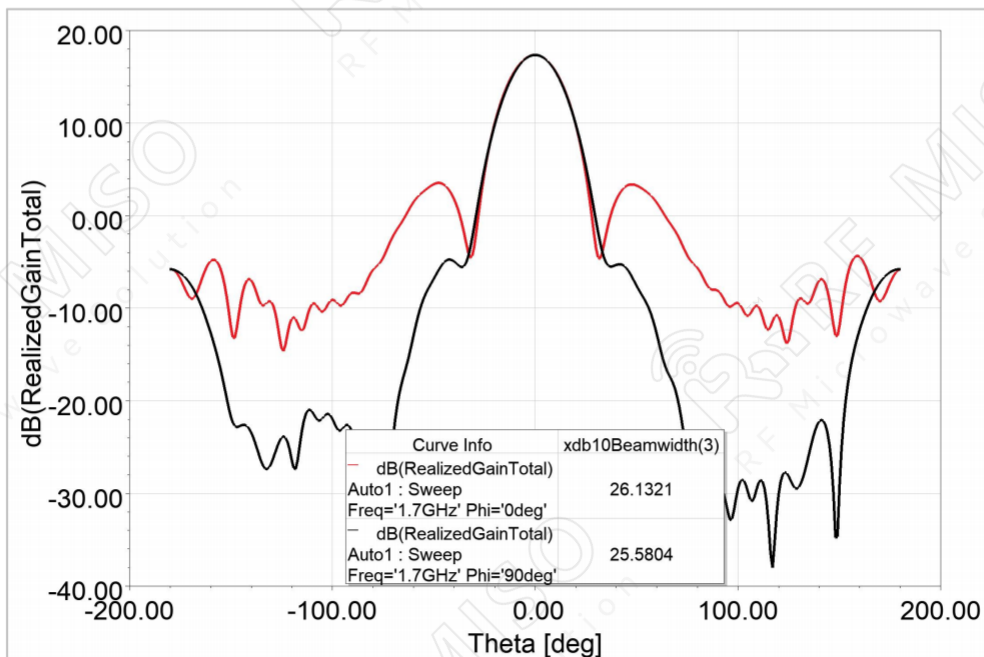

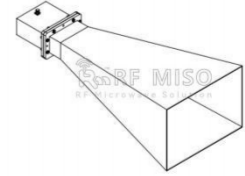

Standard Gain Horn Antenna  
15dBi Typ. Gain, 1-1.8 GHz Frequency Range

**Standard Gain Horn Antenna Data Sheet**

**RM-SGHA650-15**

1.8 GHz

