

Trihedral Corner Reflector Data Sheet

RM-TCR152.4

Features

- Ideal for RCS measurement
- High fault tolerance
- Indoor and outdoor application

Descriptions

RF MISO's **Model RM-TCR152.4** is a trihedral corner reflector, which has a robust aluminum construction that can be used to reflect radio waves directly and passively back to the transmitting source and is highly fault-tolerant. The retroreflection of the reflectors is specially designed to have high smoothness and finish in the reflection cavity, which can be widely used for RCS measurement and other applications.

Specifications

RM-TCR152.4		
Parameters	Specifications	Units
Edge Length	152.4	mm
Finishing	Plait	
Weight	0.218	Kg
Material	Al	

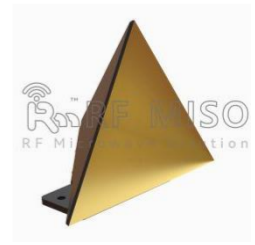

Trihedral Corner Reflector Data Sheet

RM-TCR152.4

Outline Drawing

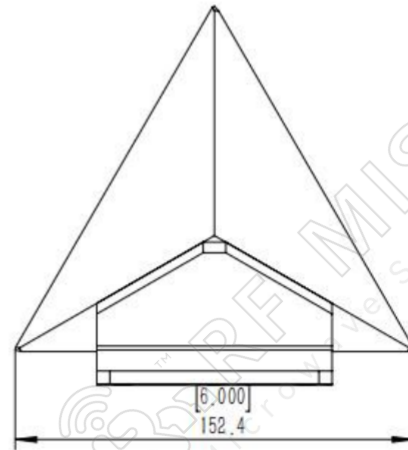
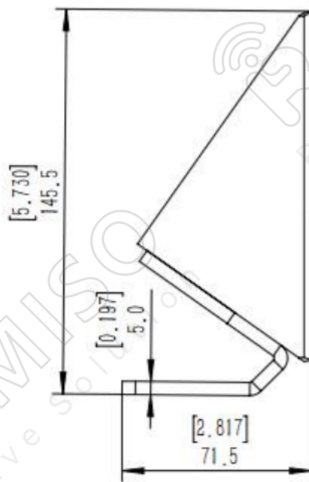
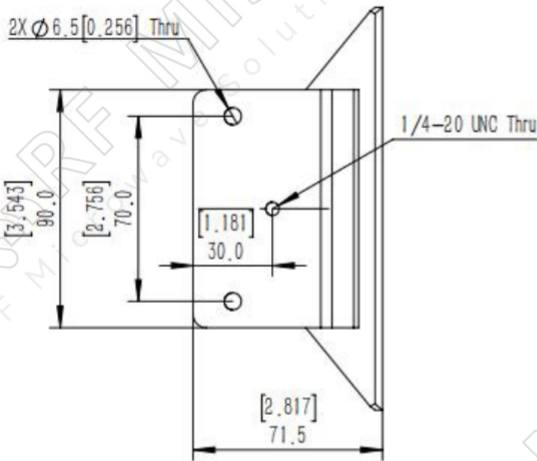

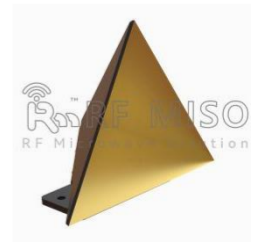

Trihedral Corner Reflector Data Sheet

RM-TCR152.4

Test Result

