

Specifications

RM-WCA3337-6		
Item	Specification	Units
Frequency Range	33-37	GHz
Gain	>5.9	dBi
VSWR	<2	
Cross polarization	48 Typ.	dB
Polarization Mode	Linear-polarized	
Connector	2.92-Female	
Material	Al	
Size(L*W*H)	24.9*18.7*6.6	mm
Weight	0.003	kg

Outline Drawing

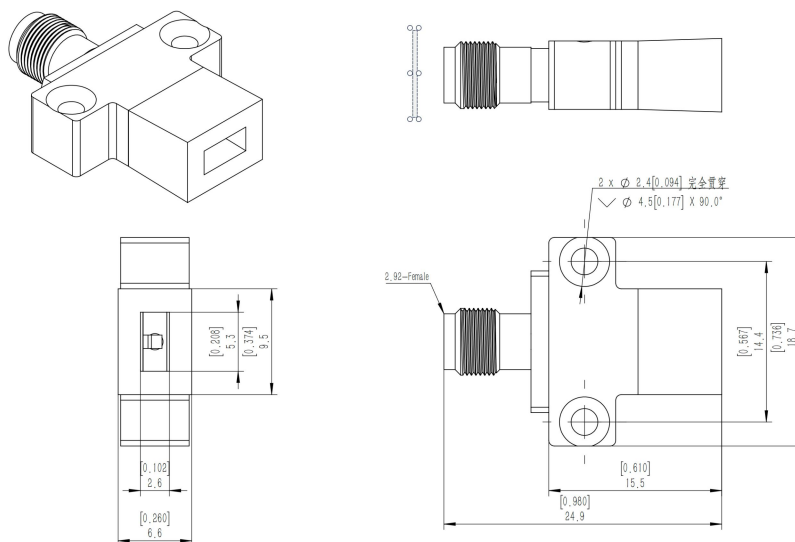

Simulation Data

VSWR

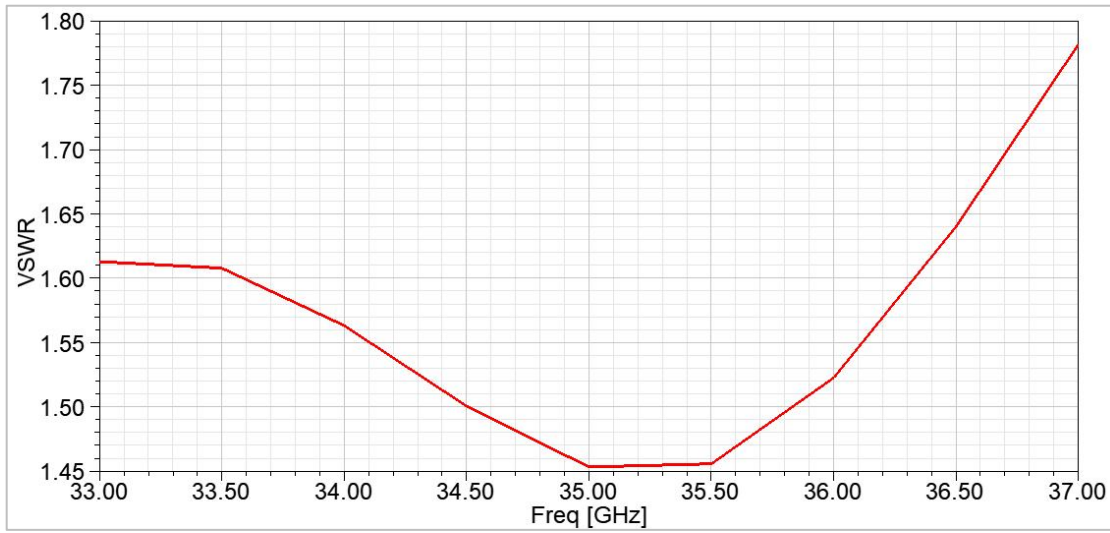

Gain

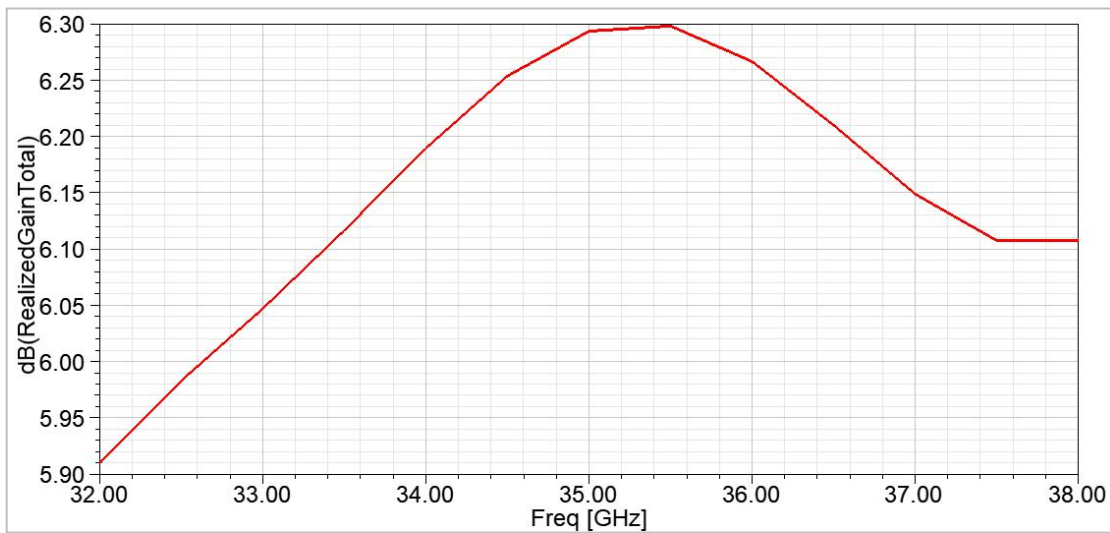

Cross Polarization

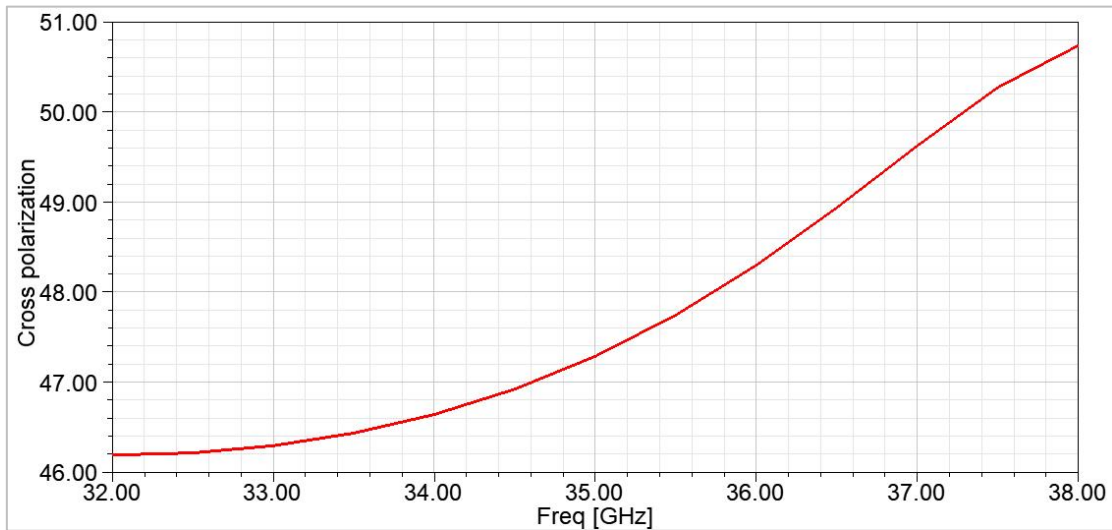

Pattern

33 GHz

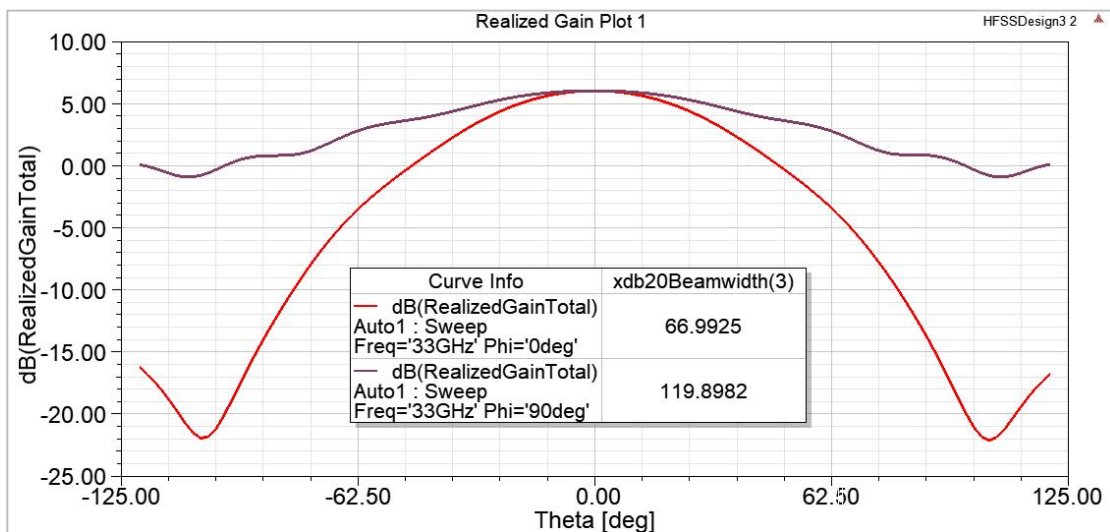

Waveguide to Coaxial Adapter  
33-37GHz Frequency Range

**Waveguide to Coaxial Adapter Date Sheet**

**RM-WCA3337-6**

34 GHz

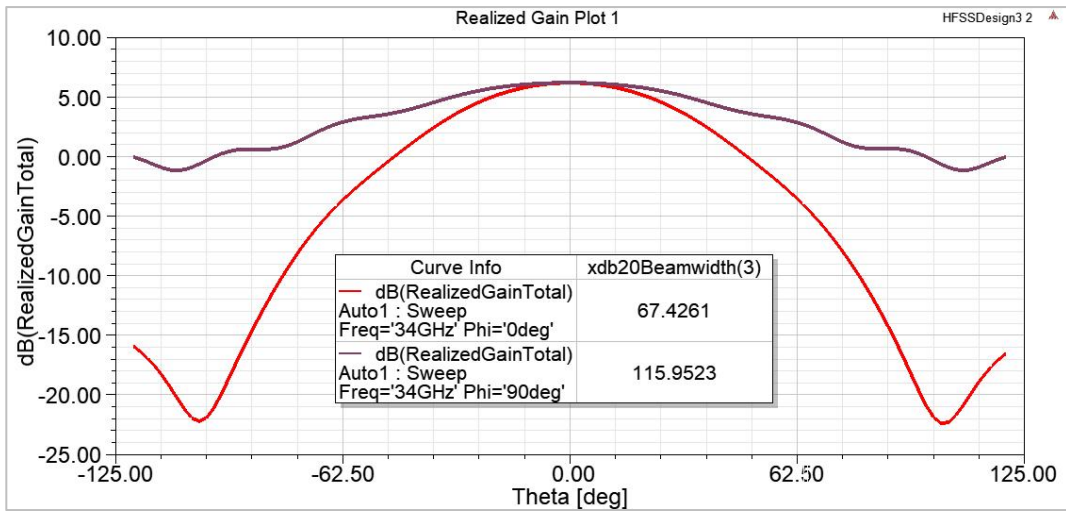

35GHz

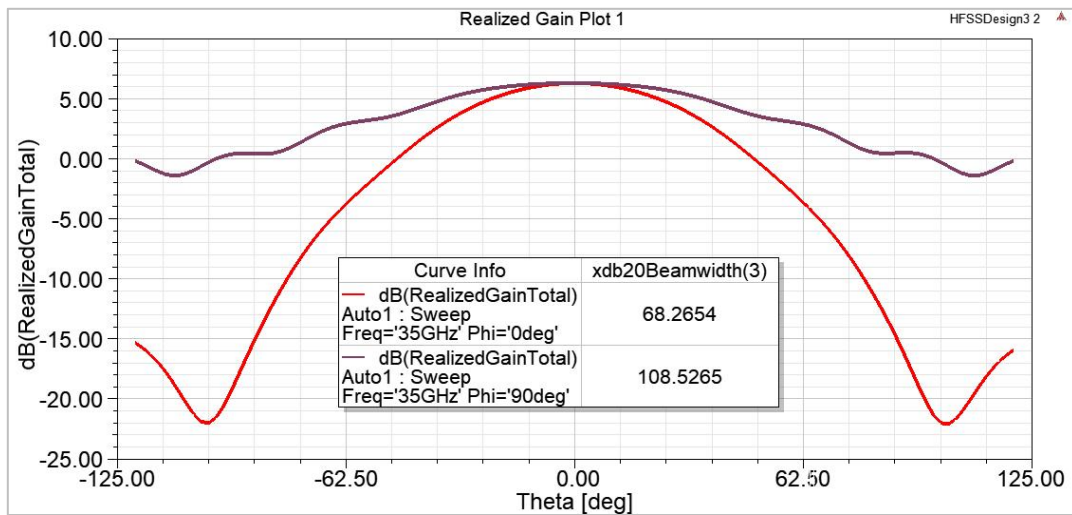

Waveguide to Coaxial Adapter  
33-37GHz Frequency Range

**Waveguide to Coaxial Adapter Date Sheet**

**RM-WCA3337-6**

36GHz

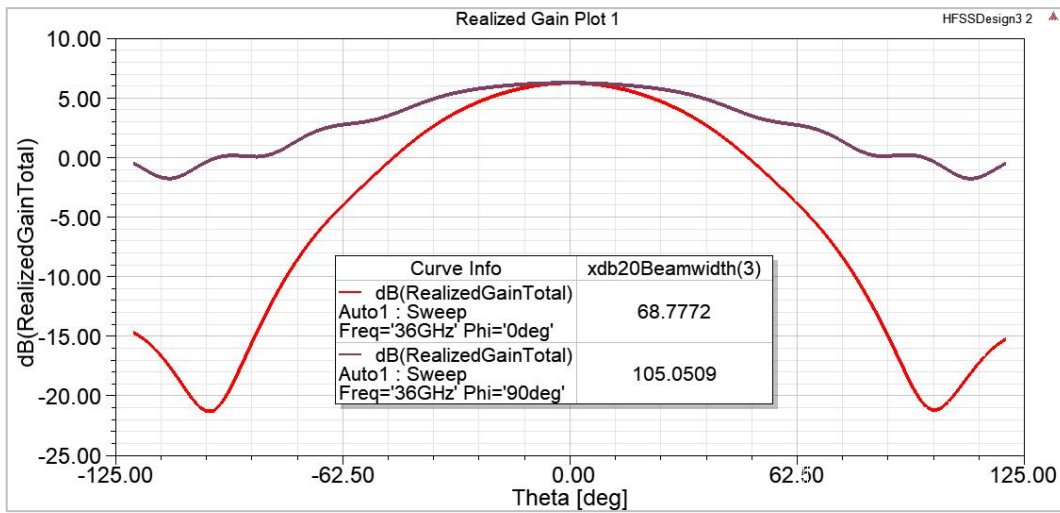

37GHz

